

SOJAG

produits saisonniers • seasonal products

Sojag code: 500-9165166

CUP/UPC code: 772830165166

QUESTIONS? 1 855-659-4402

Assembly Manual / Guide d'assemblage / Manual de ensamblaje / 조립설명서 / Montageanleitung

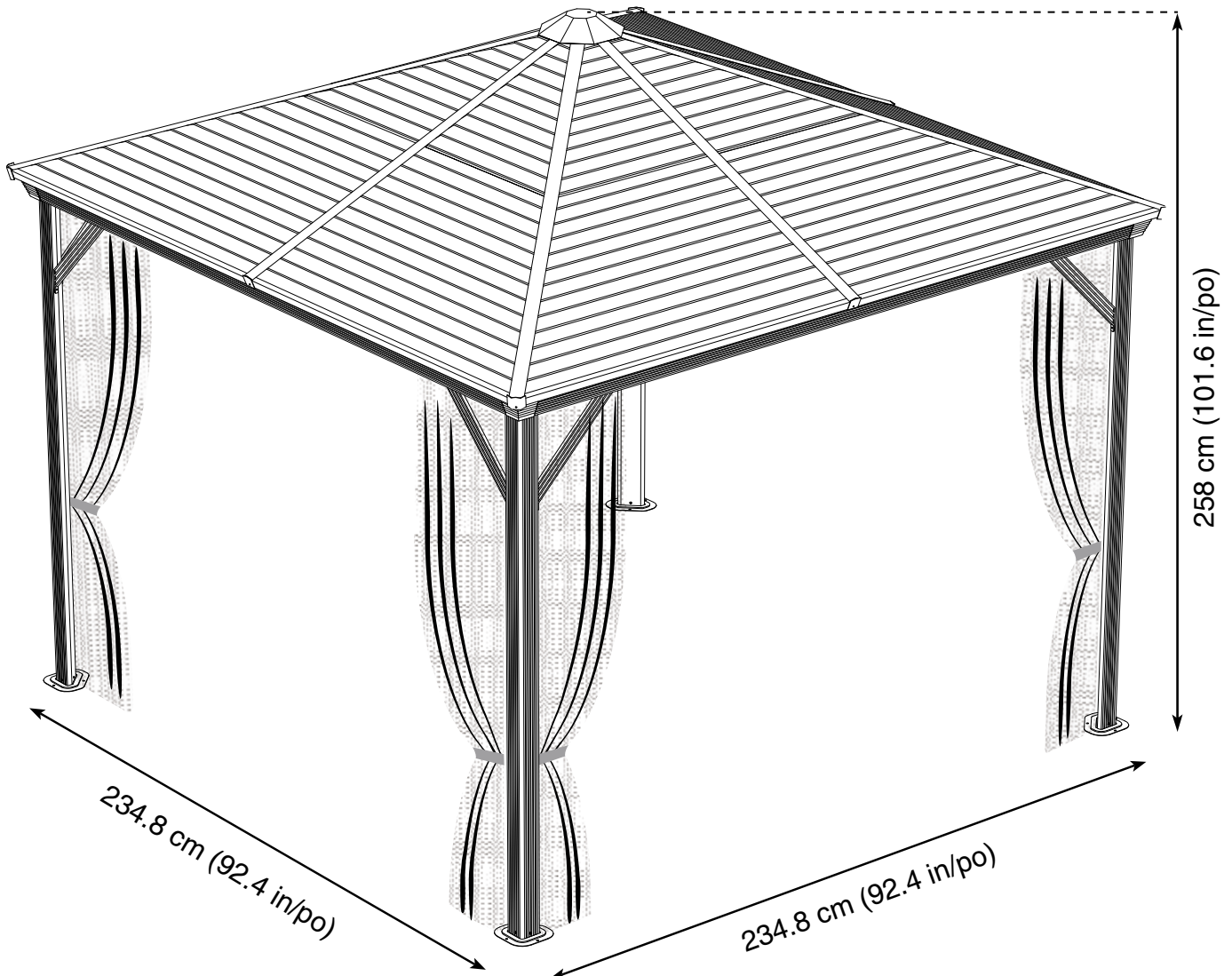

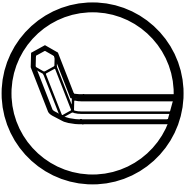

Use the hex keys in the box. / Utilisez les clés hexagonales fournies dans la boîte. /
Utilice las llaves hexagonales en la caja. / 상자에 육각 키를 사용 하십시오. / Verwenden Sie
die Sechskantschlüssel in der Box.

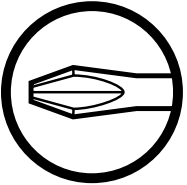

Please use a Phillips screwdriver. / Utilisez un tournevis de type Phillips / Por favor,
use un destornillador Phillips. / 십자 드라이버를 사용 하십시오. / Bitte verwenden
Sie einen Kreuzschraubenzieher.



You may need to use a drill for this step. / Vous pouvez avoir besoin d'utiliser une
perceuse pour cette étape. / Puede que tenga que utilizar un taladro para este paso. /
이 단계에선 드릴을 사용해야 할 수도 있습니다. / Für diesen Schritt können Sie einen
Bohrer verwenden.



Wearing protective gloves is recommended. / Le port de gants de protection est recommandé /
El uso de guantes de protección se recomienda. / 보호 장갑을 착용 하는 것이 좋습니다. /
Das Tragen von Schutzhandschuhen wird empfohlen.



Two or more people are required at this stage. / Deux personnes ou plus sont nécessaires à cette
étape. / Dos o más personas se requieren en esta etapa. / 이 단계에서는 두 명 이상 이 필요합니다. /
Für diesen Bauschritt sind 2 oder mehr Personen erforderlich.

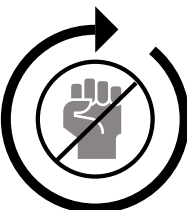

Do not tighten screws all the way for now. / Ne pas visser fermement pour l'instant. /
No atornille con firmeza por ahora. / 아직 나사를 단단히 조이지 마십시오. / Bitte die
Schrauben zum jetzigen Zeitpunkt noch nicht fest anziehen.

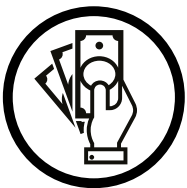

Sold separately. / Vendus séparément. / vendido en las opciones. /
옵션 판매 / Optional erhältlich

T X 8 (+2)

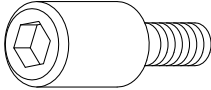

U X 16 (+2)

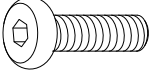

U1 X 32 (+6)

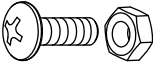

U2 X 1(+1)

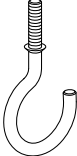

V X 36 (+5)

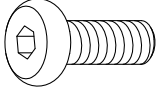

V1 X 16 (+2)

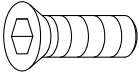

V2 X 16 (+2)

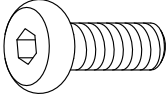

W X 24 (+3)

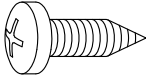

Y X 1

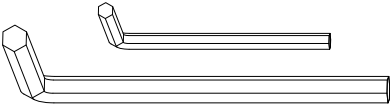

Y1 X 28 (+4)



Z2 X4 (+1)

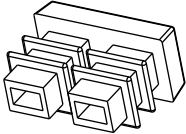

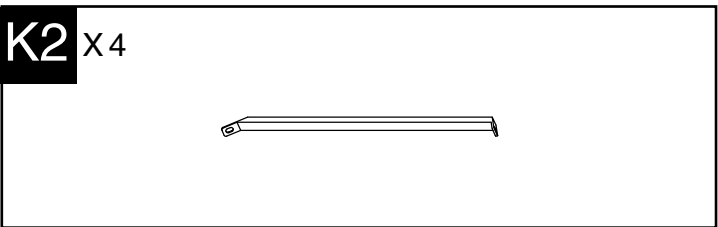
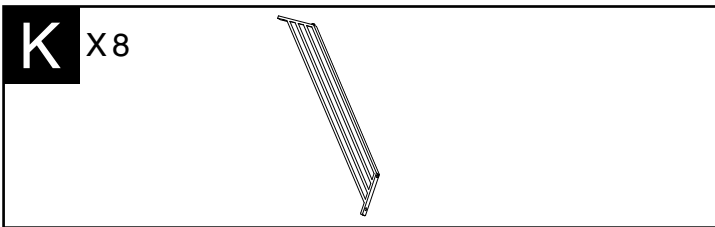
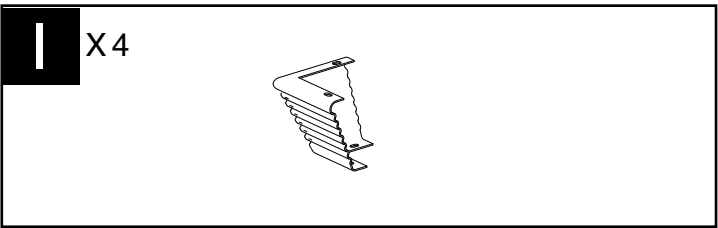
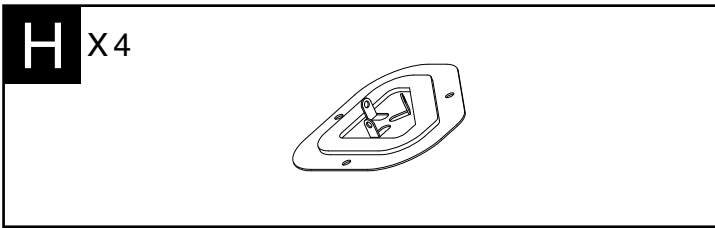
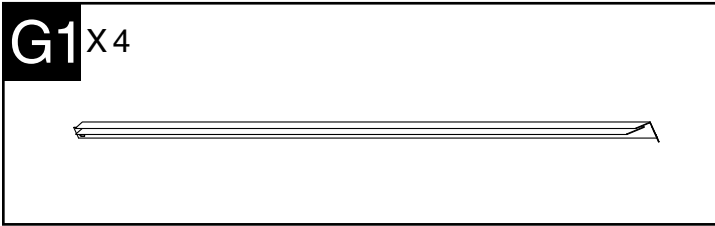
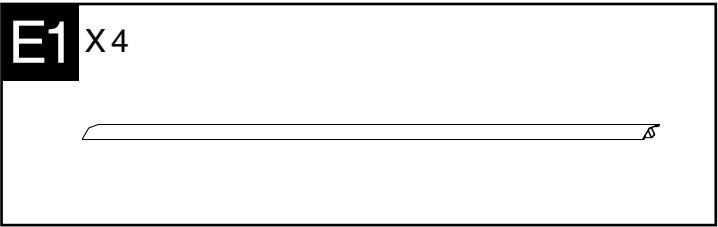
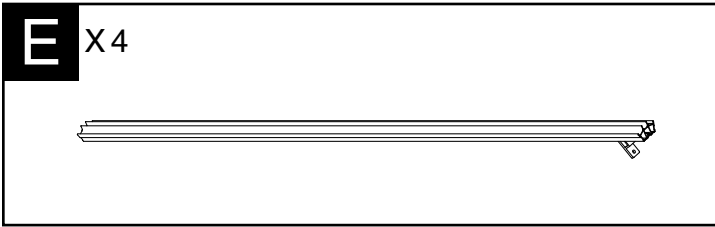
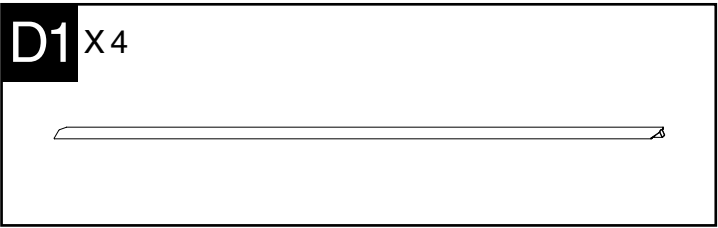
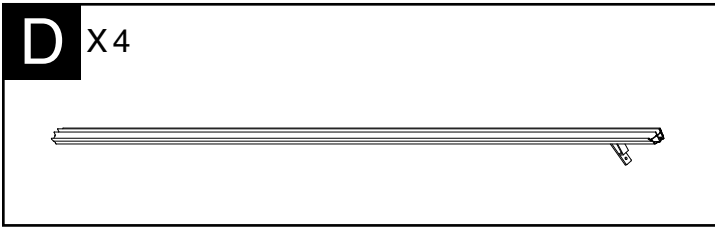
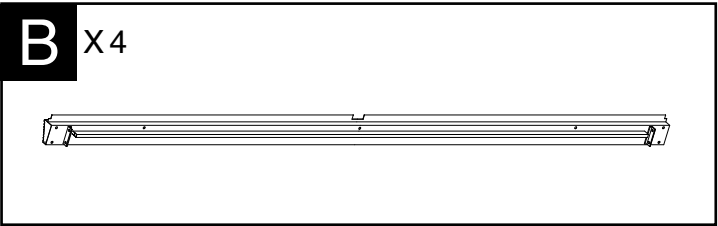

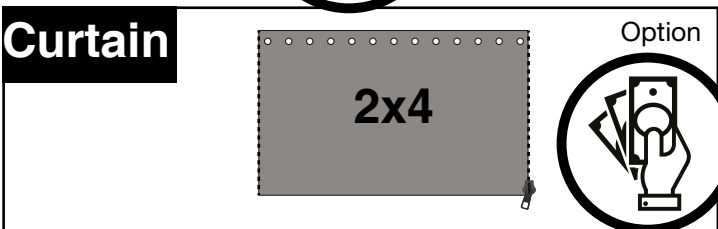
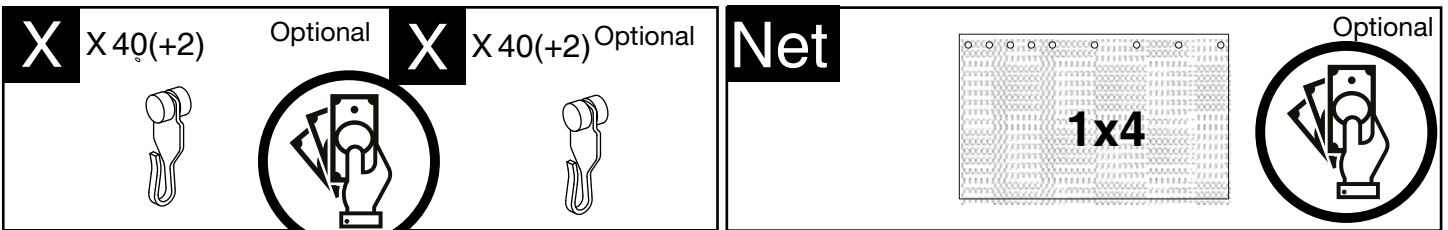
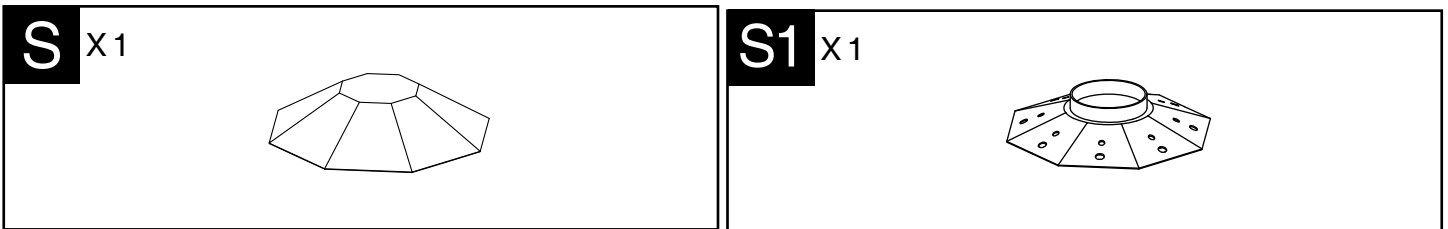
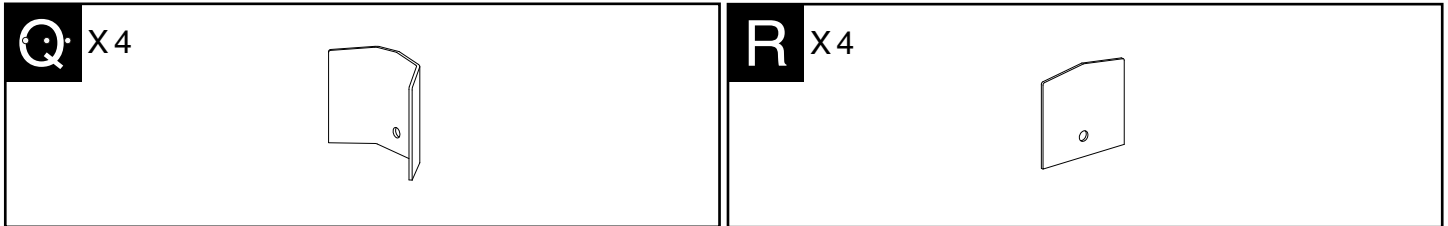
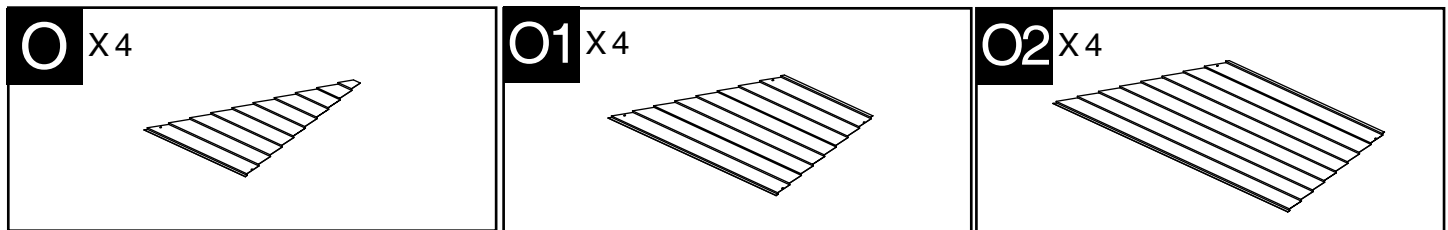
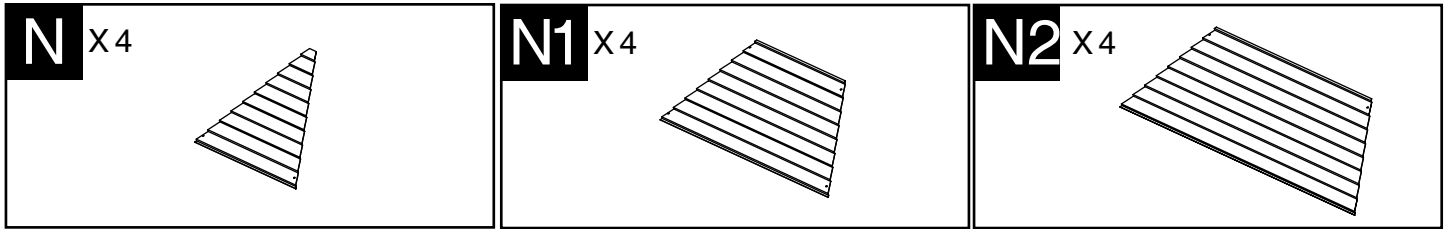

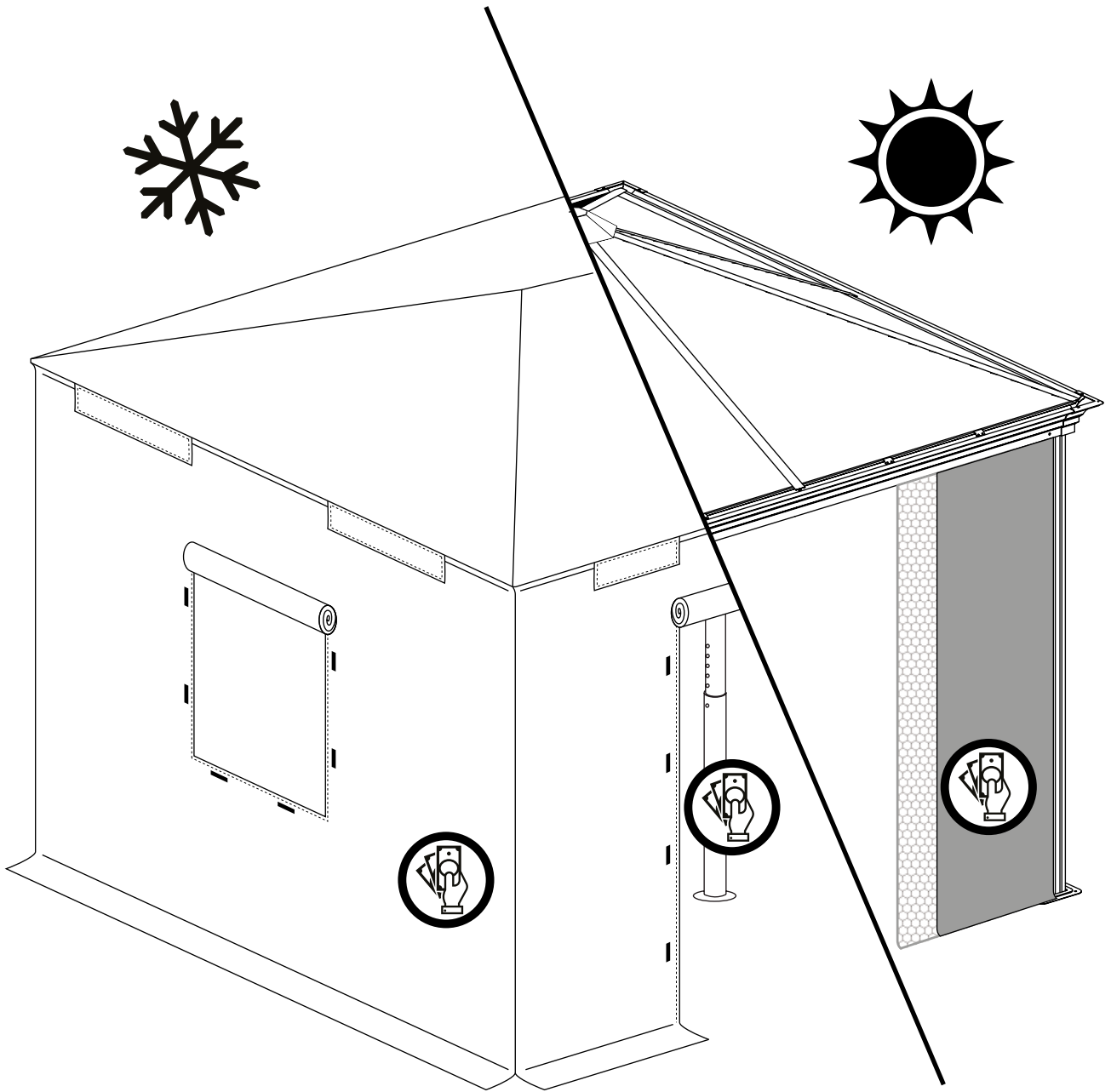
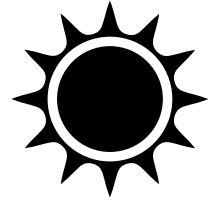
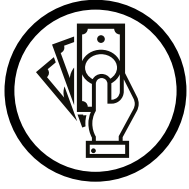

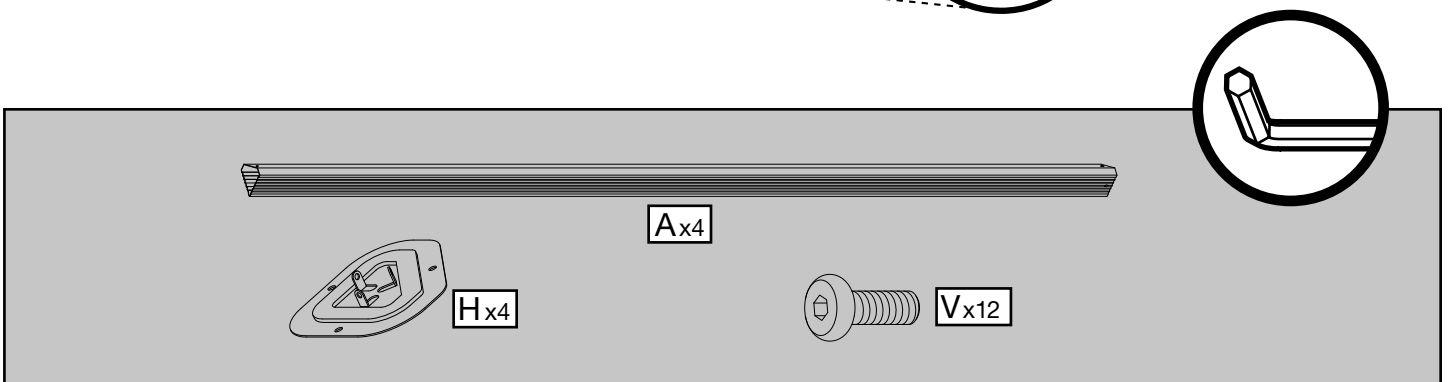
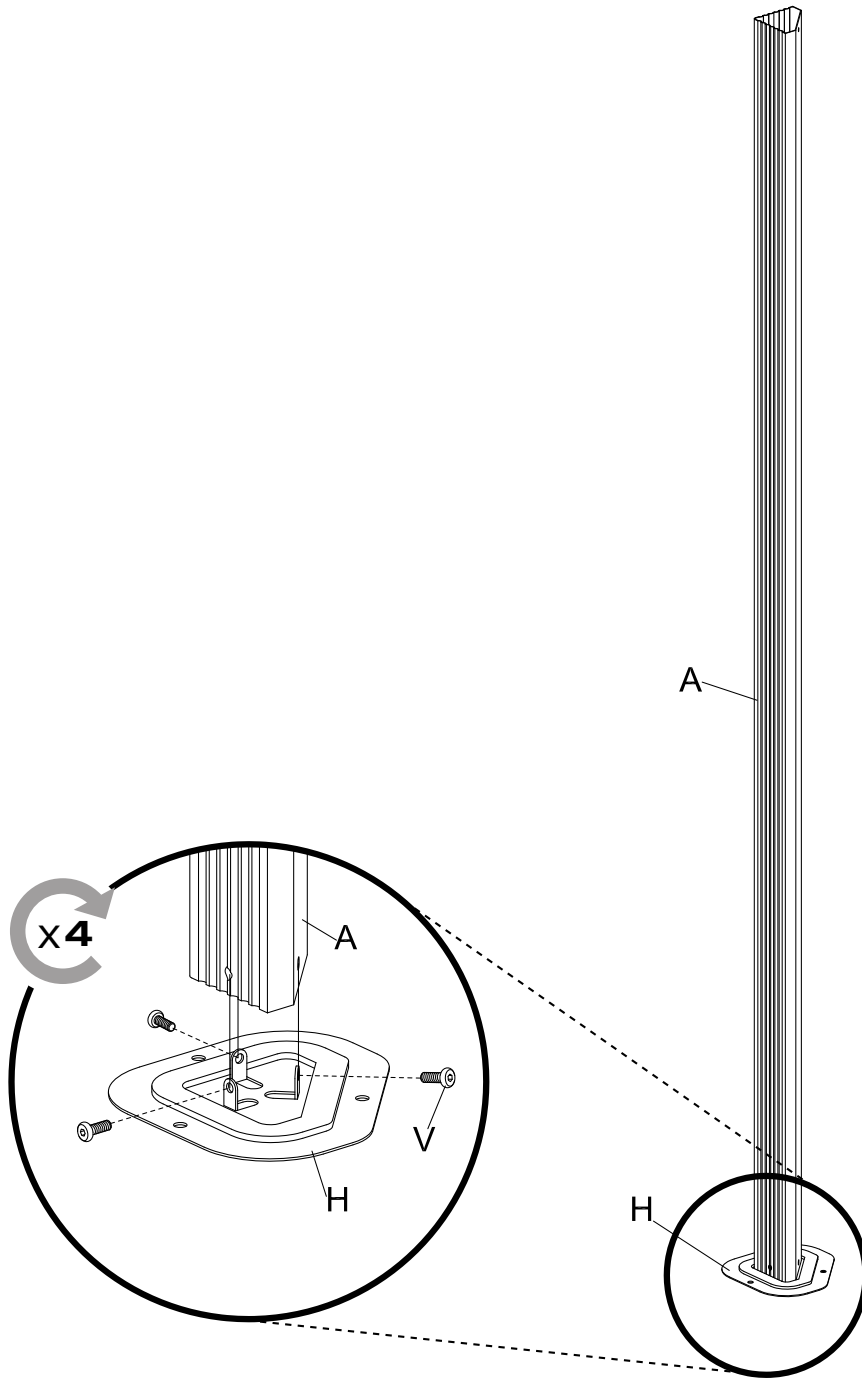

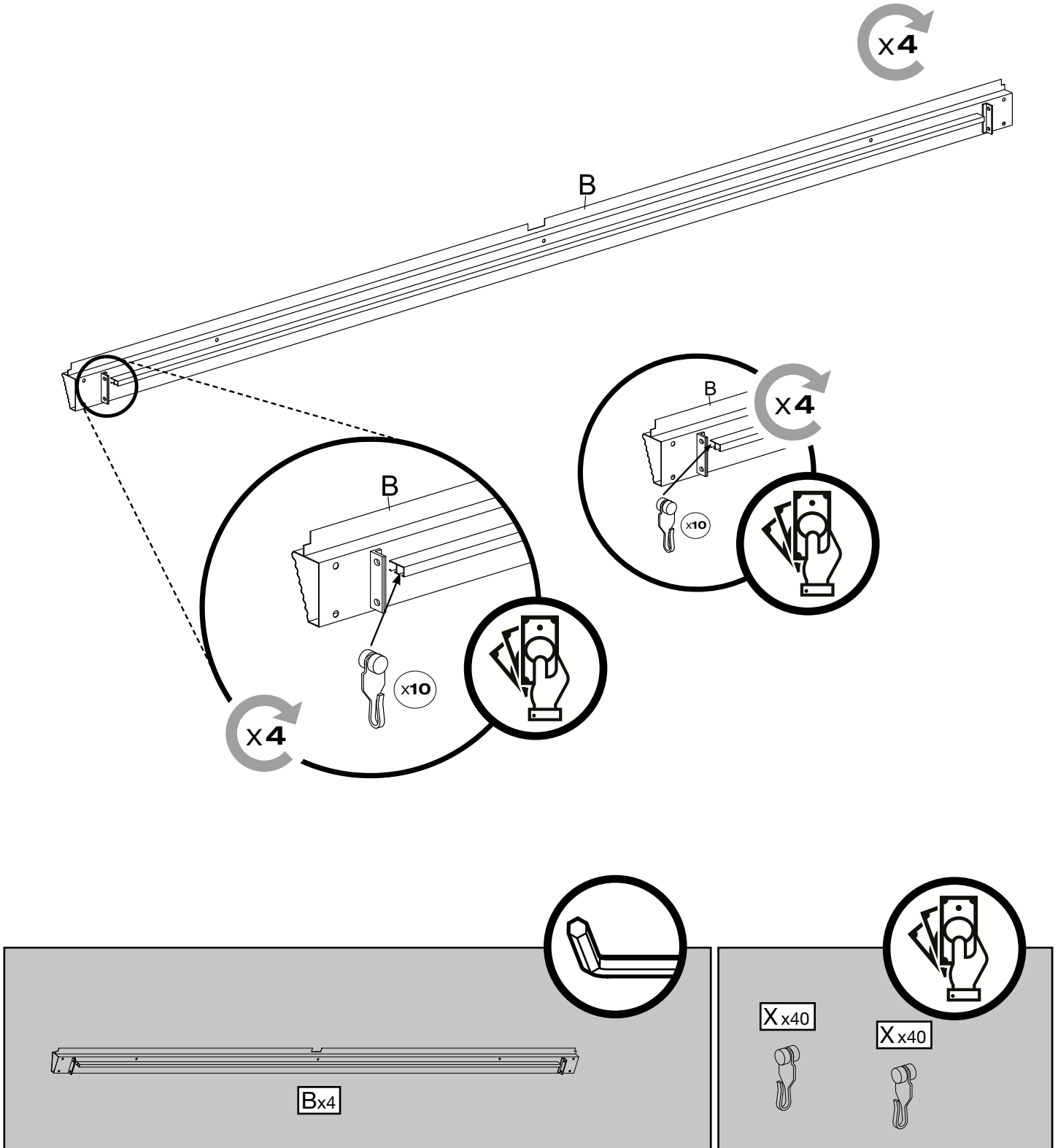

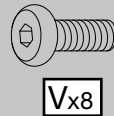
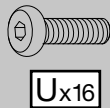
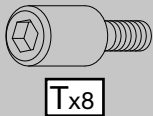
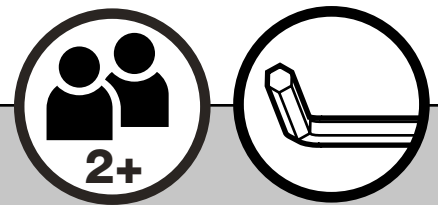
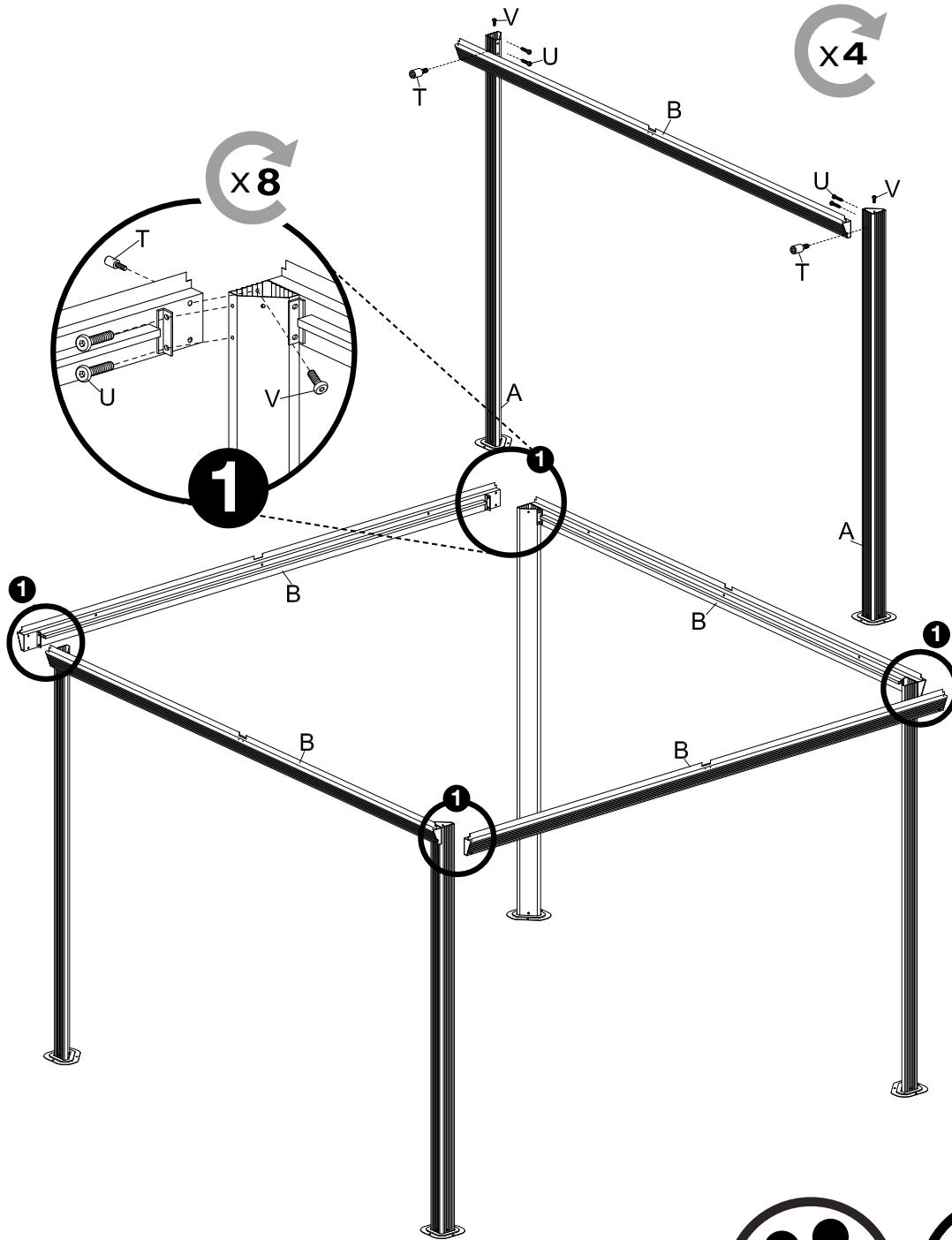

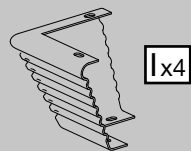
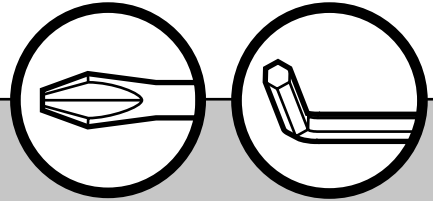
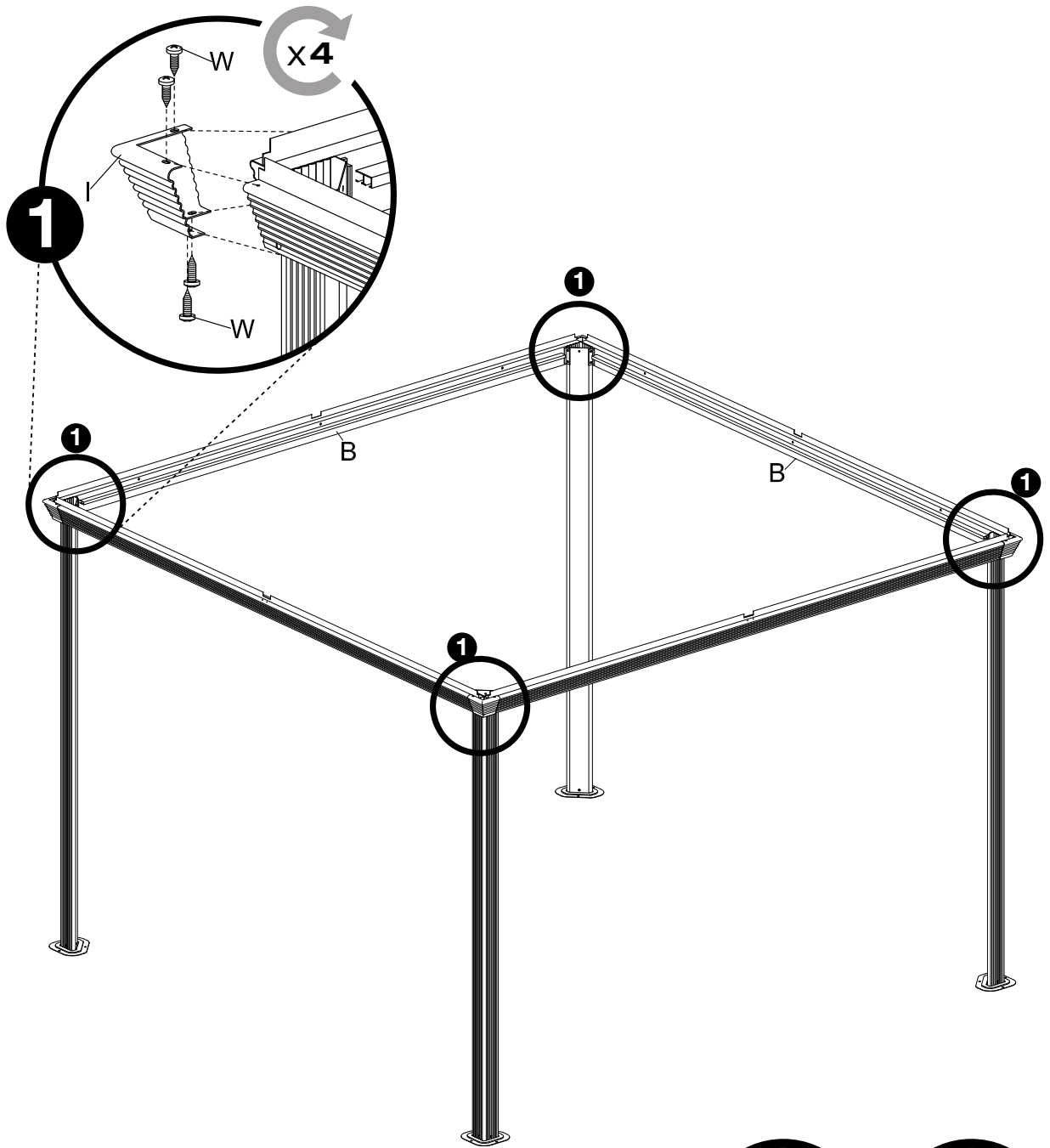

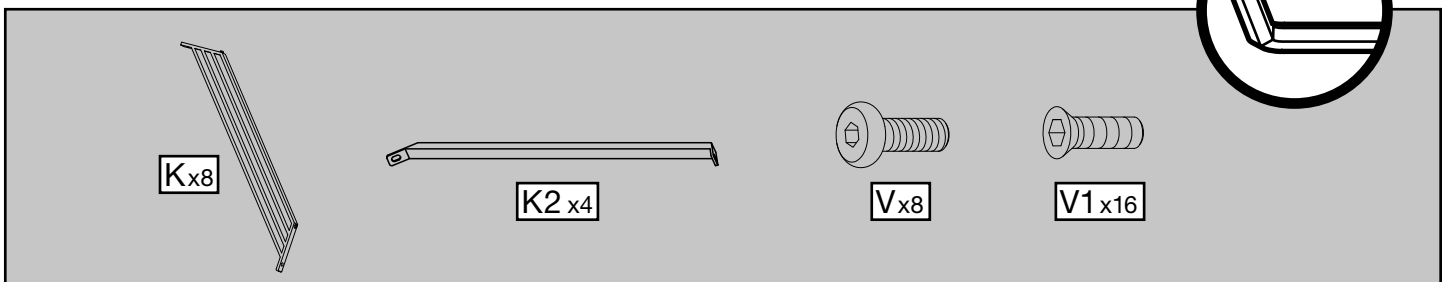
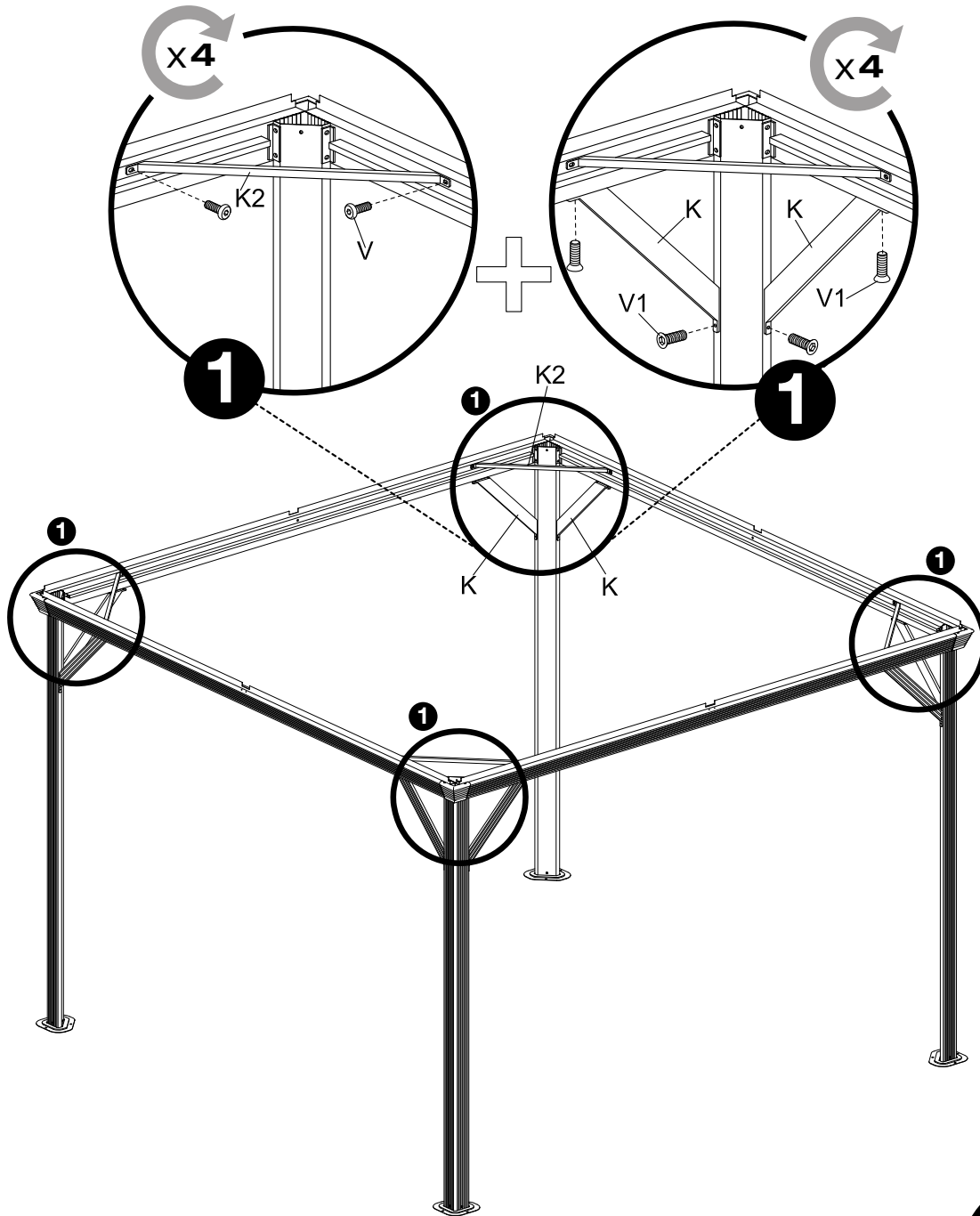

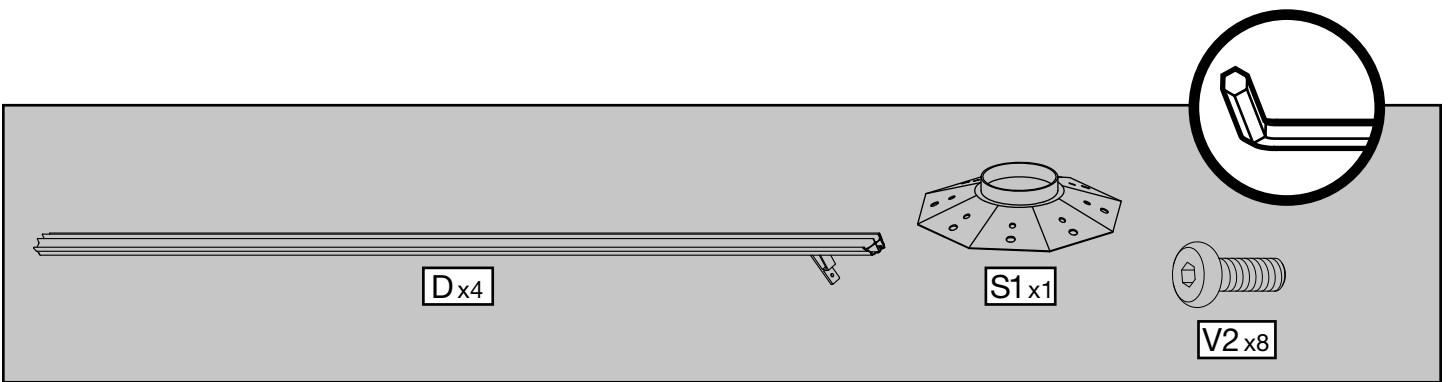
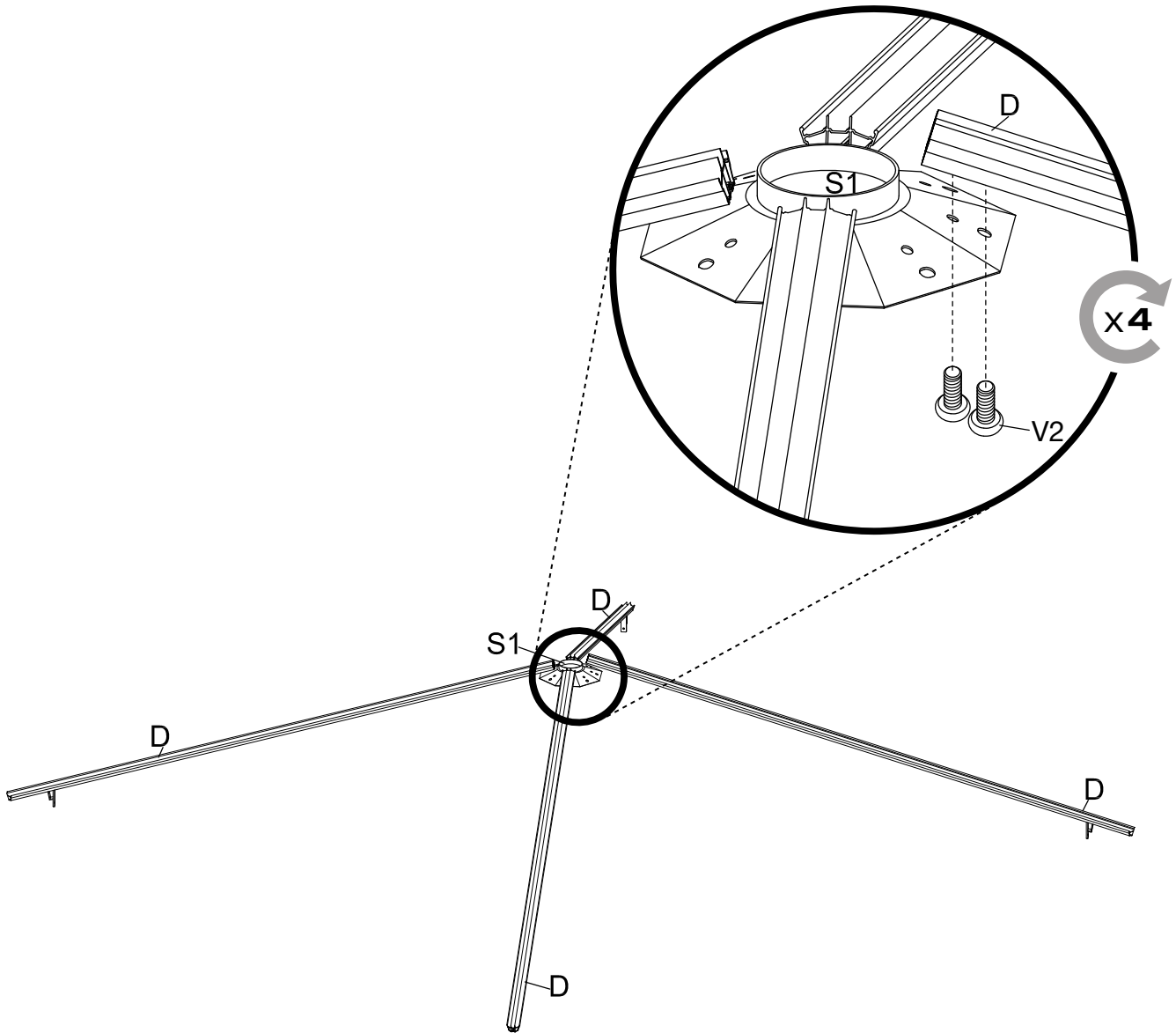

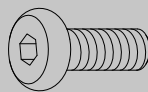
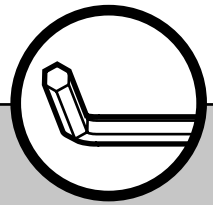
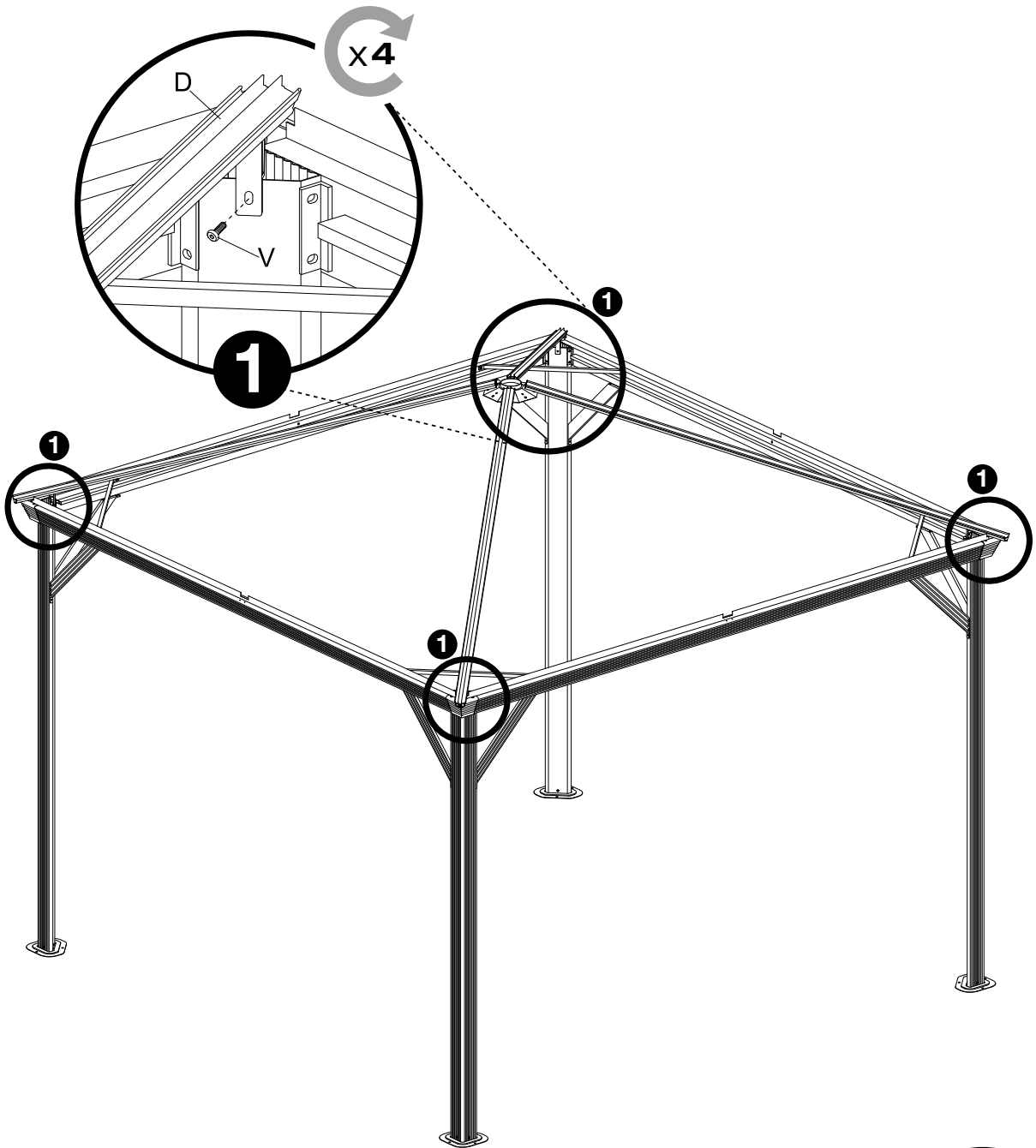

Vx4

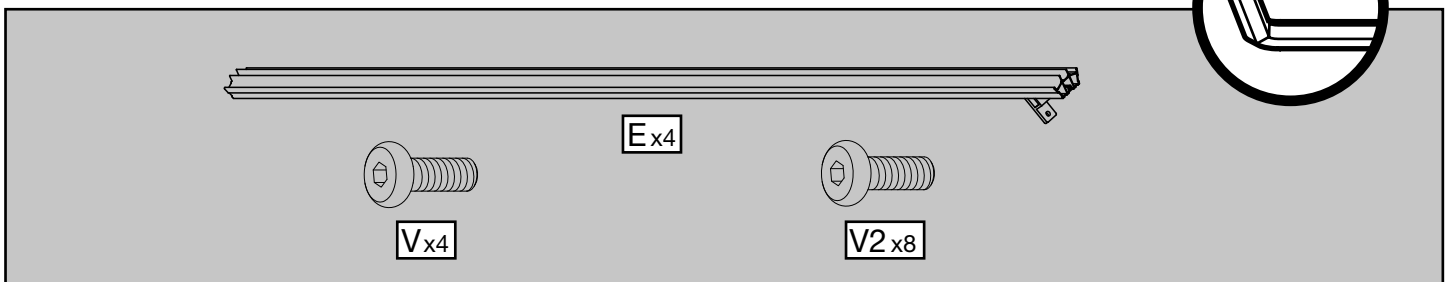
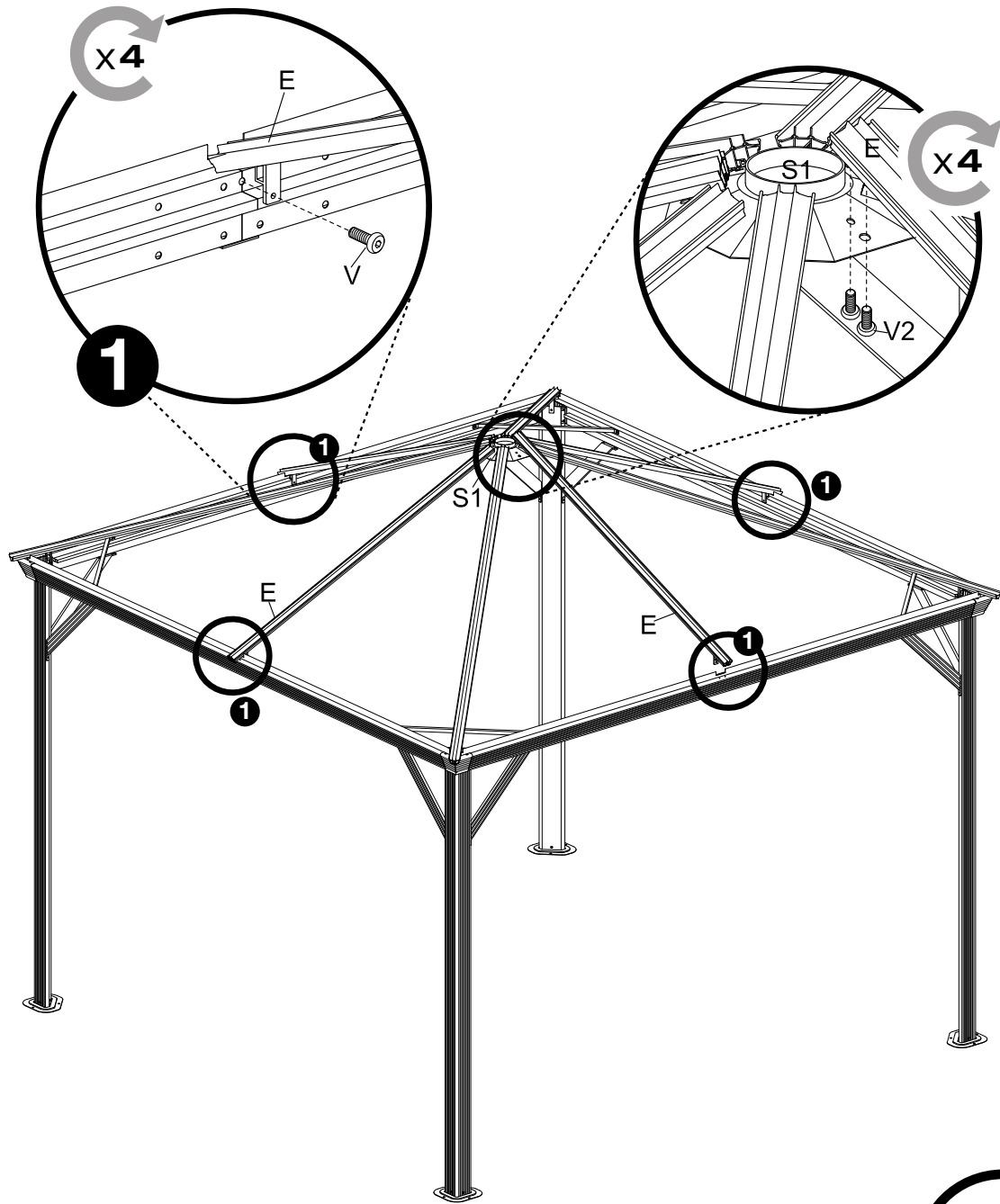

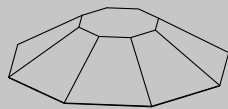
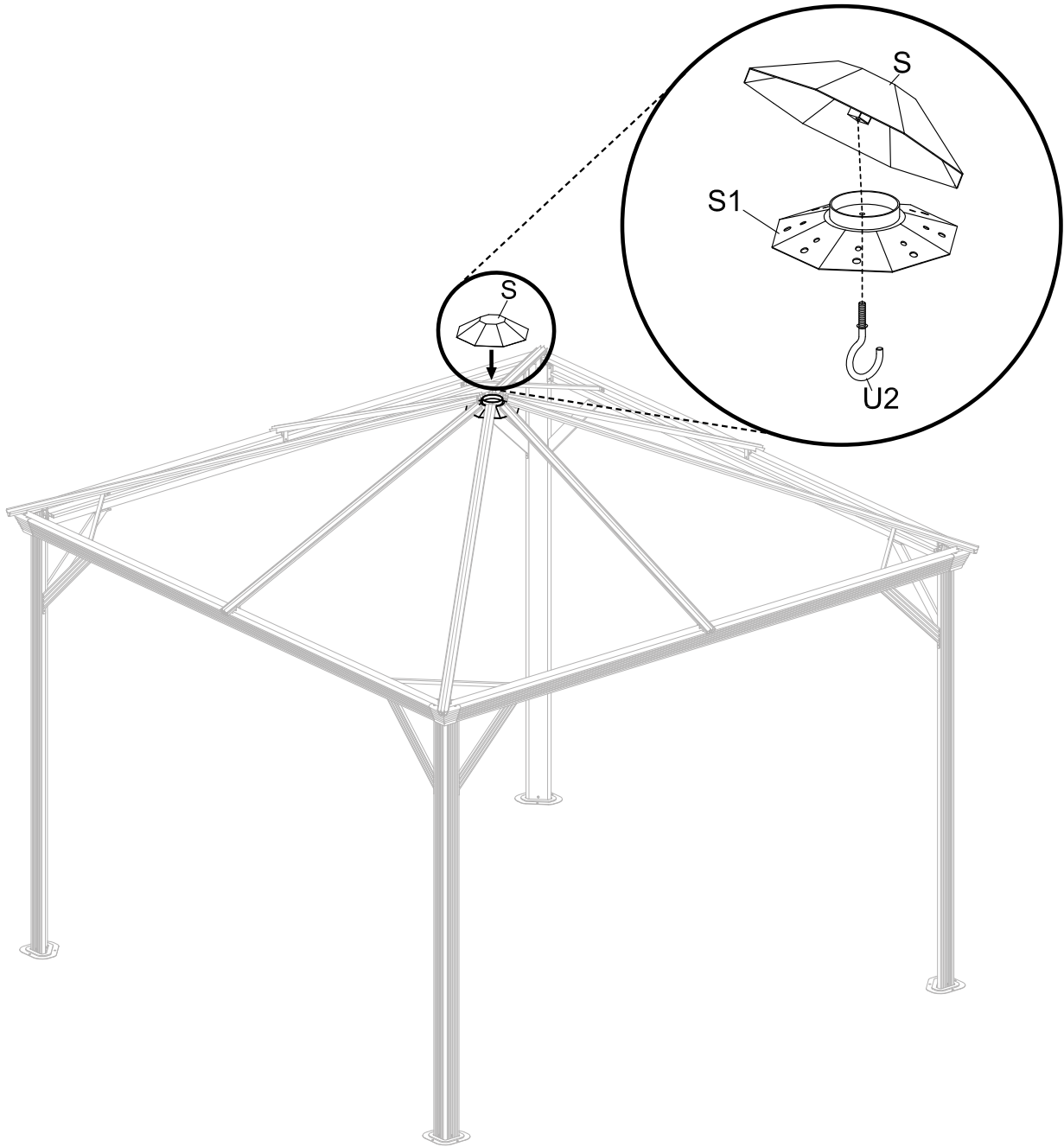

Sx1



U2x1

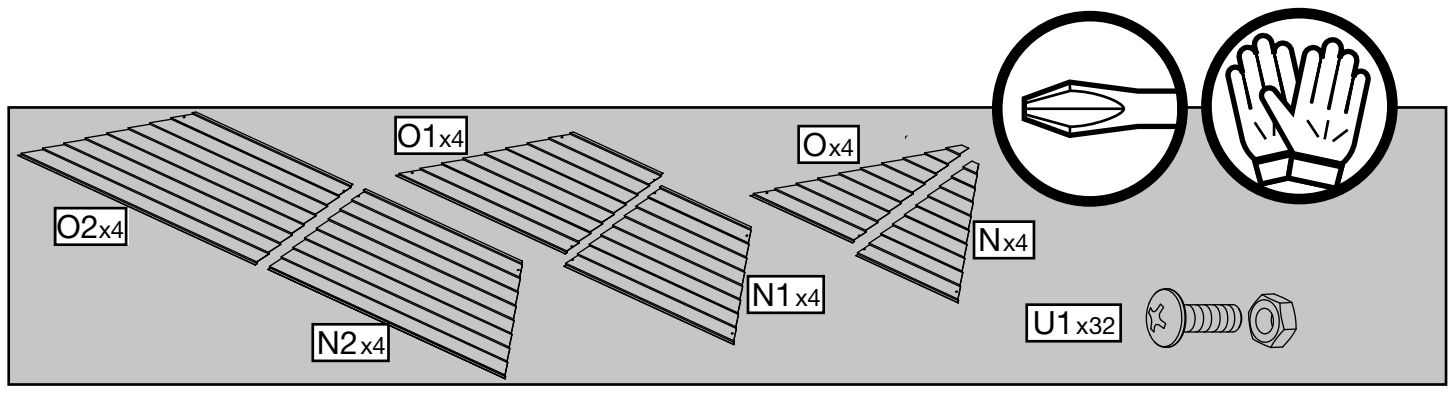
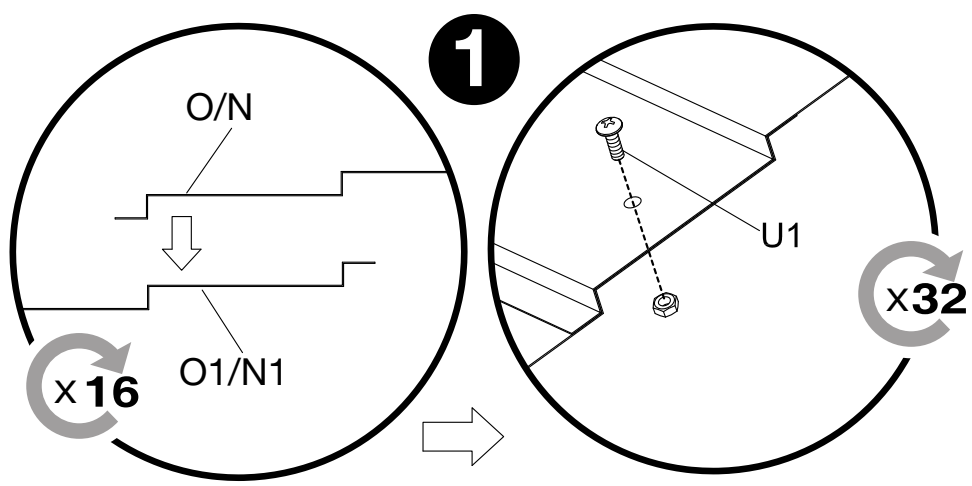
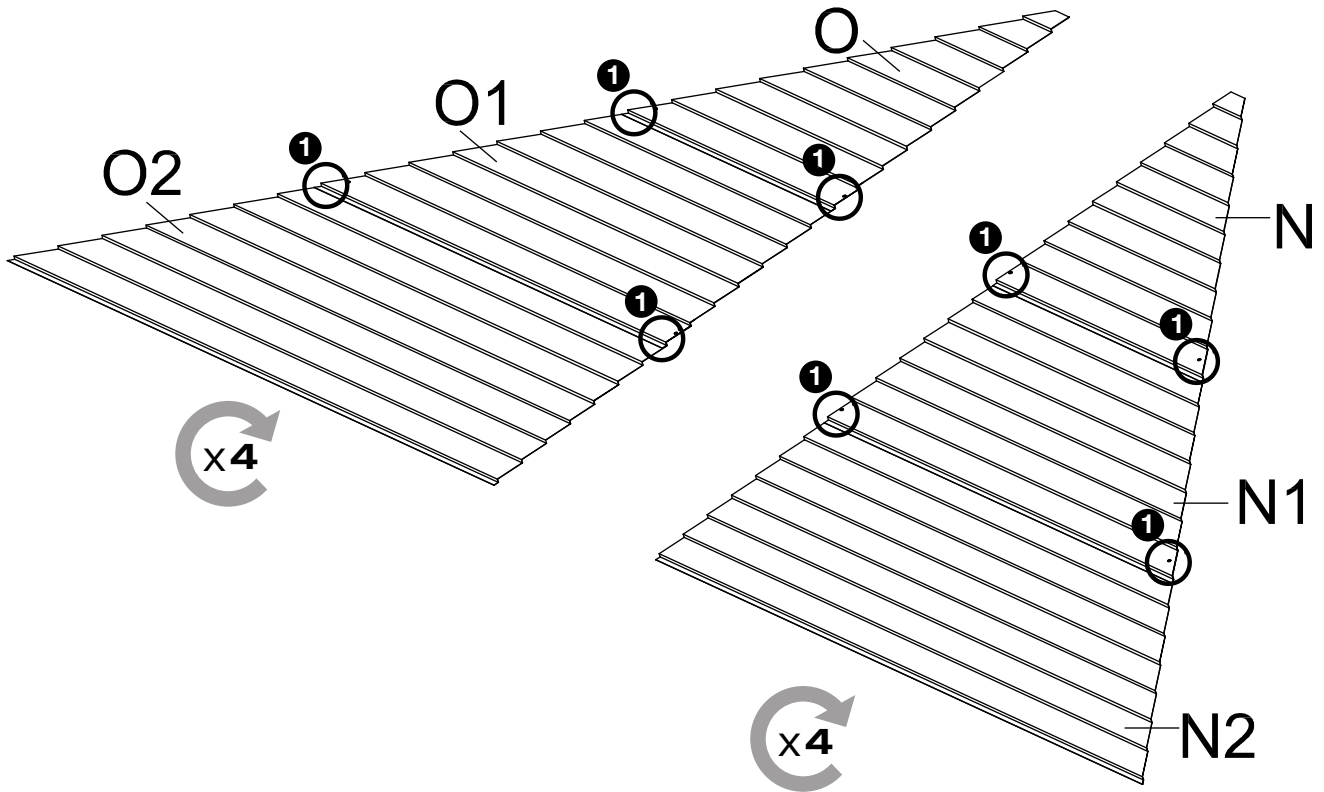

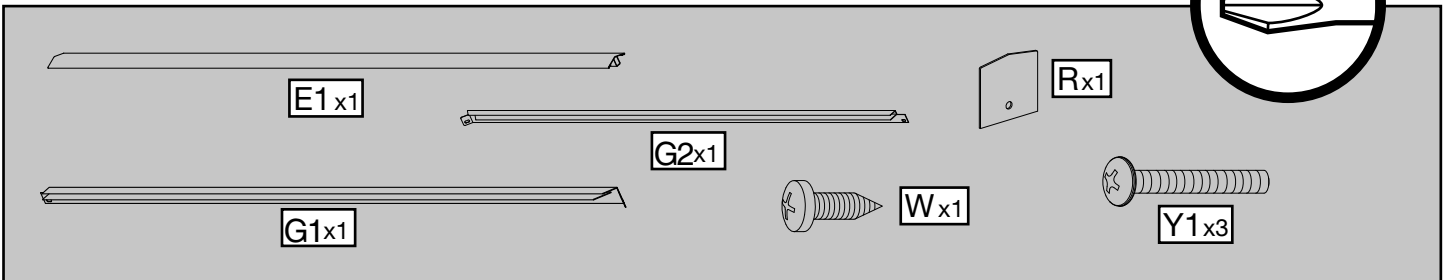
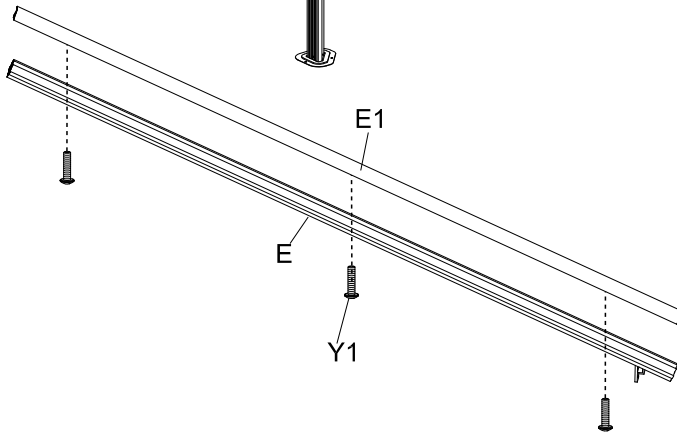
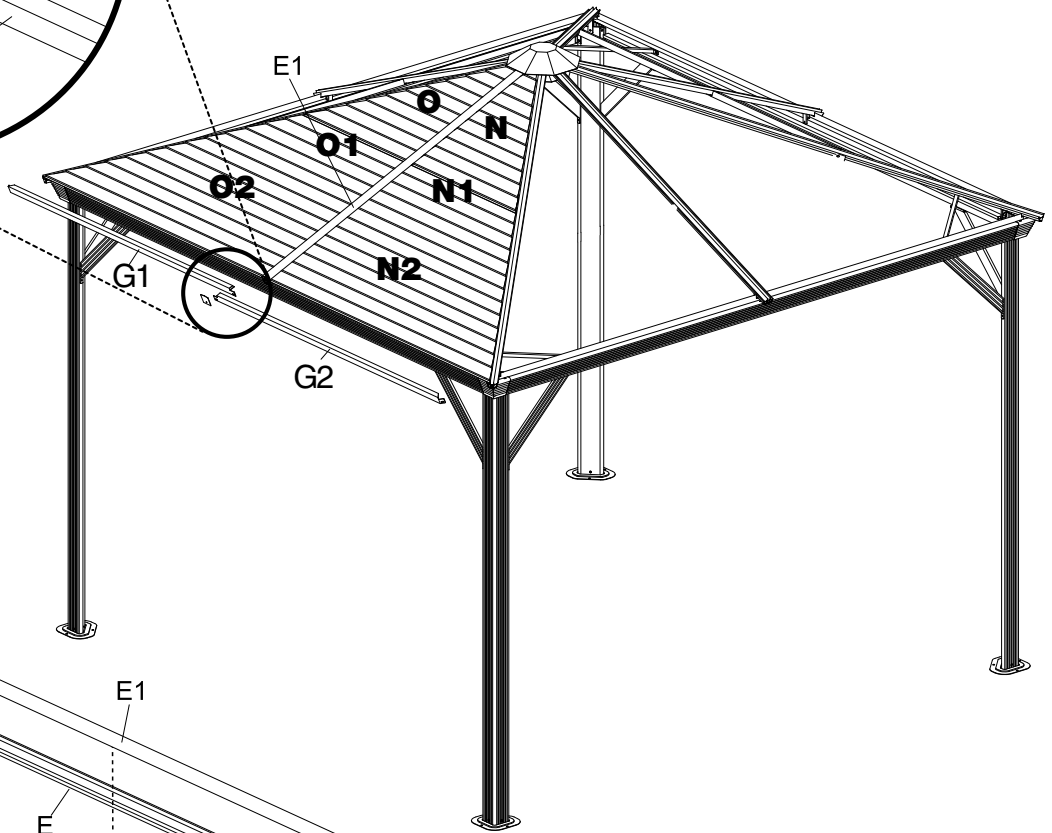
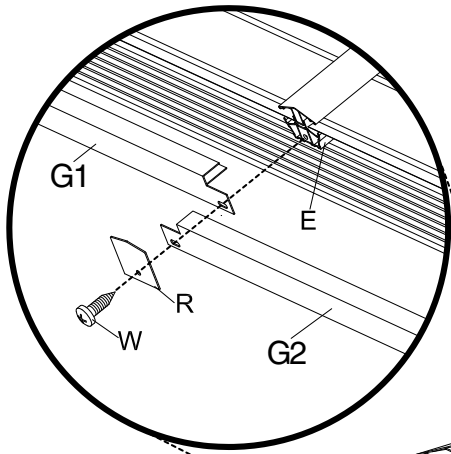

11A/13

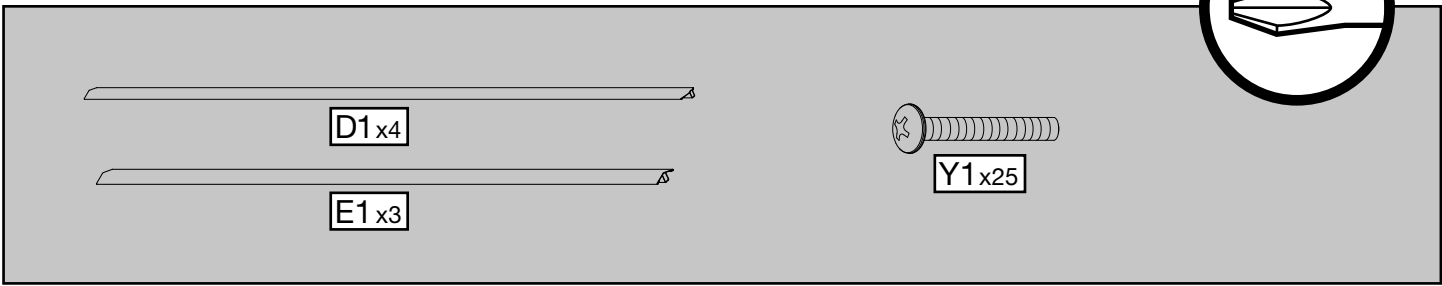
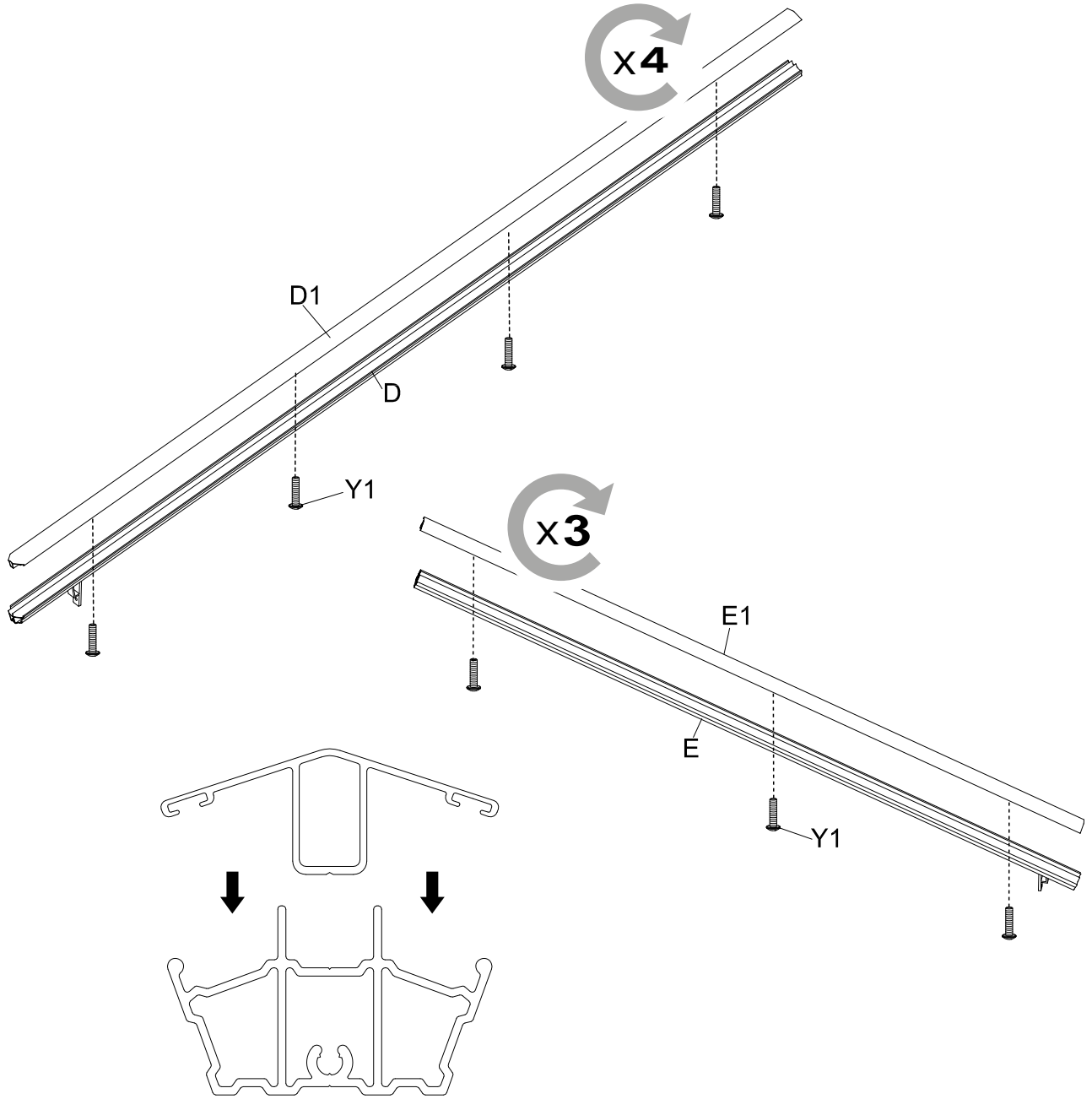

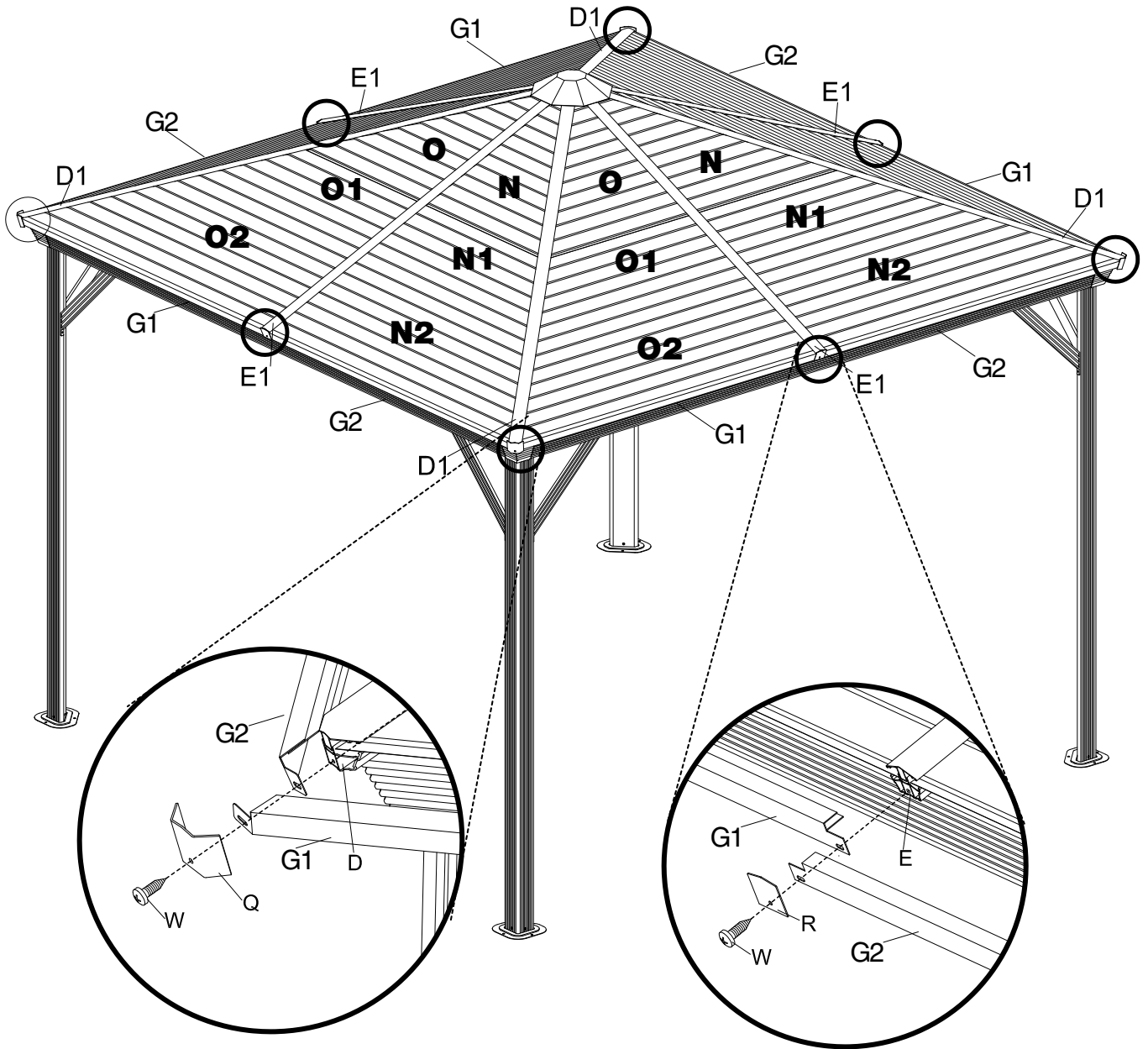

G1x3
G2x3
Qx4
Wx7
Rx3

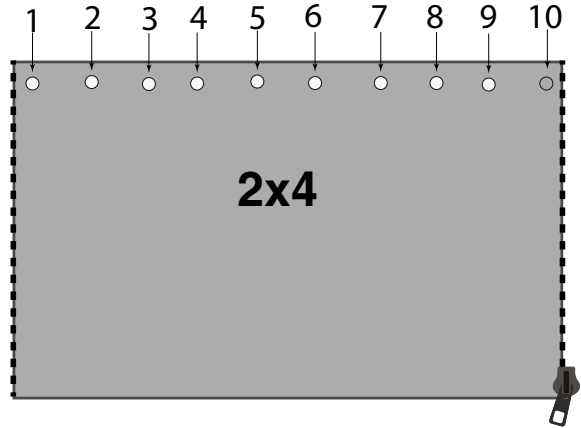
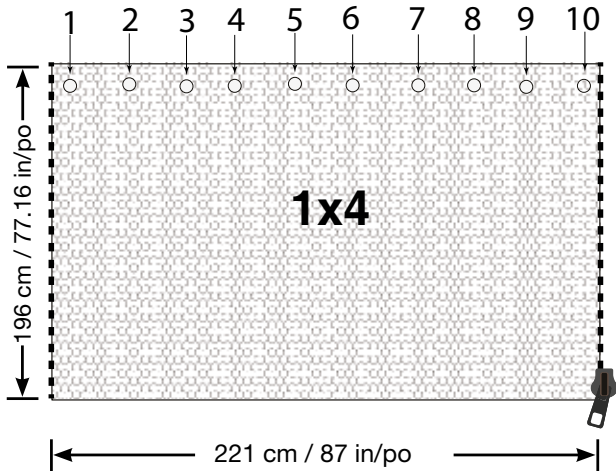
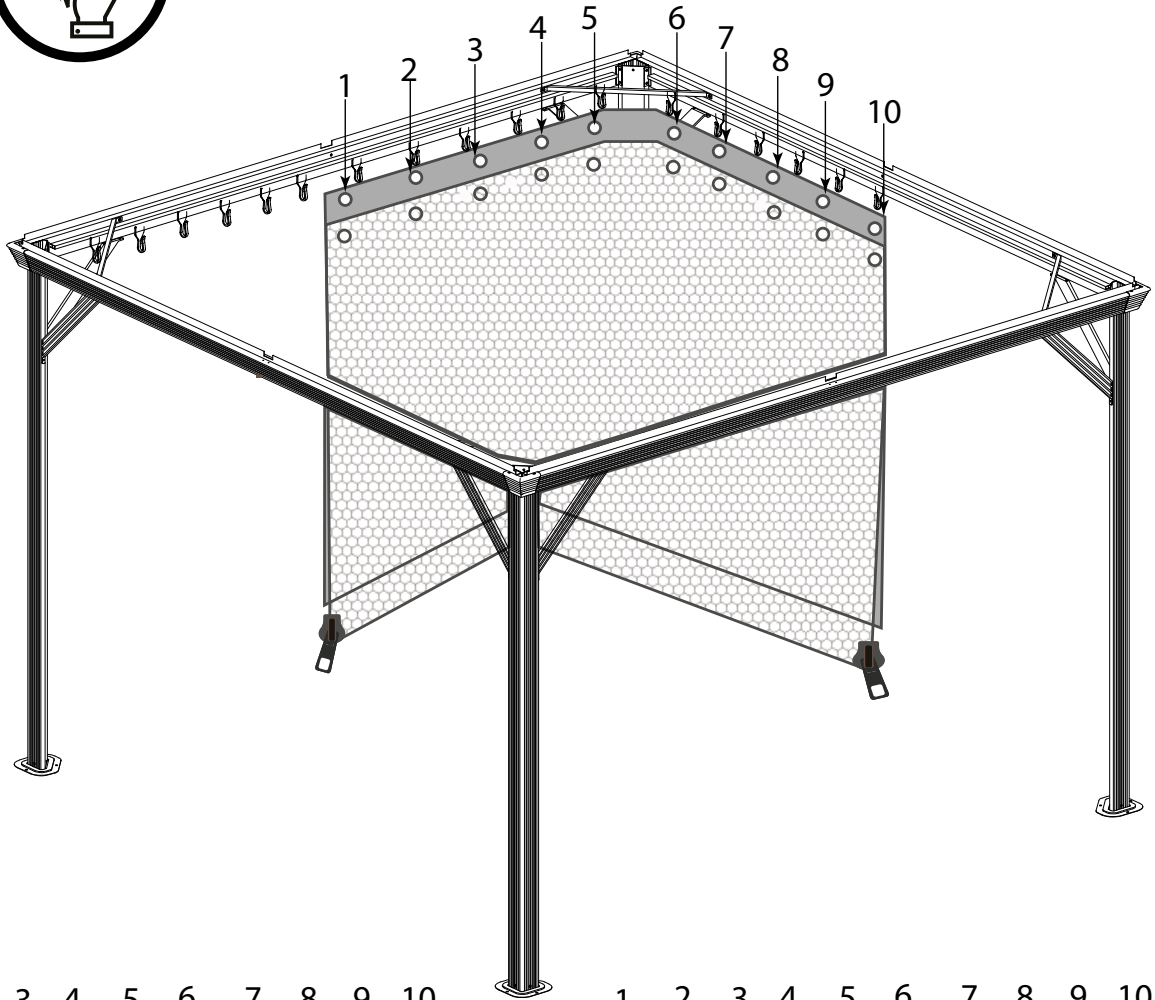
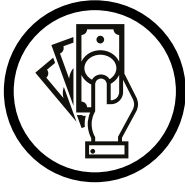

SOJAG ■ I
produits saisonniers • seasonal products