

SOJAG

produits saisonniers • seasonal products

Sojag code:500-9165142

CUP/UPC code: 772830165142

QUESTIONS? 1 866-901-1649

Assembly Manual / Guide d'assemblage / Manual de ensamblaje / 조립설명서 / Montageanleitung

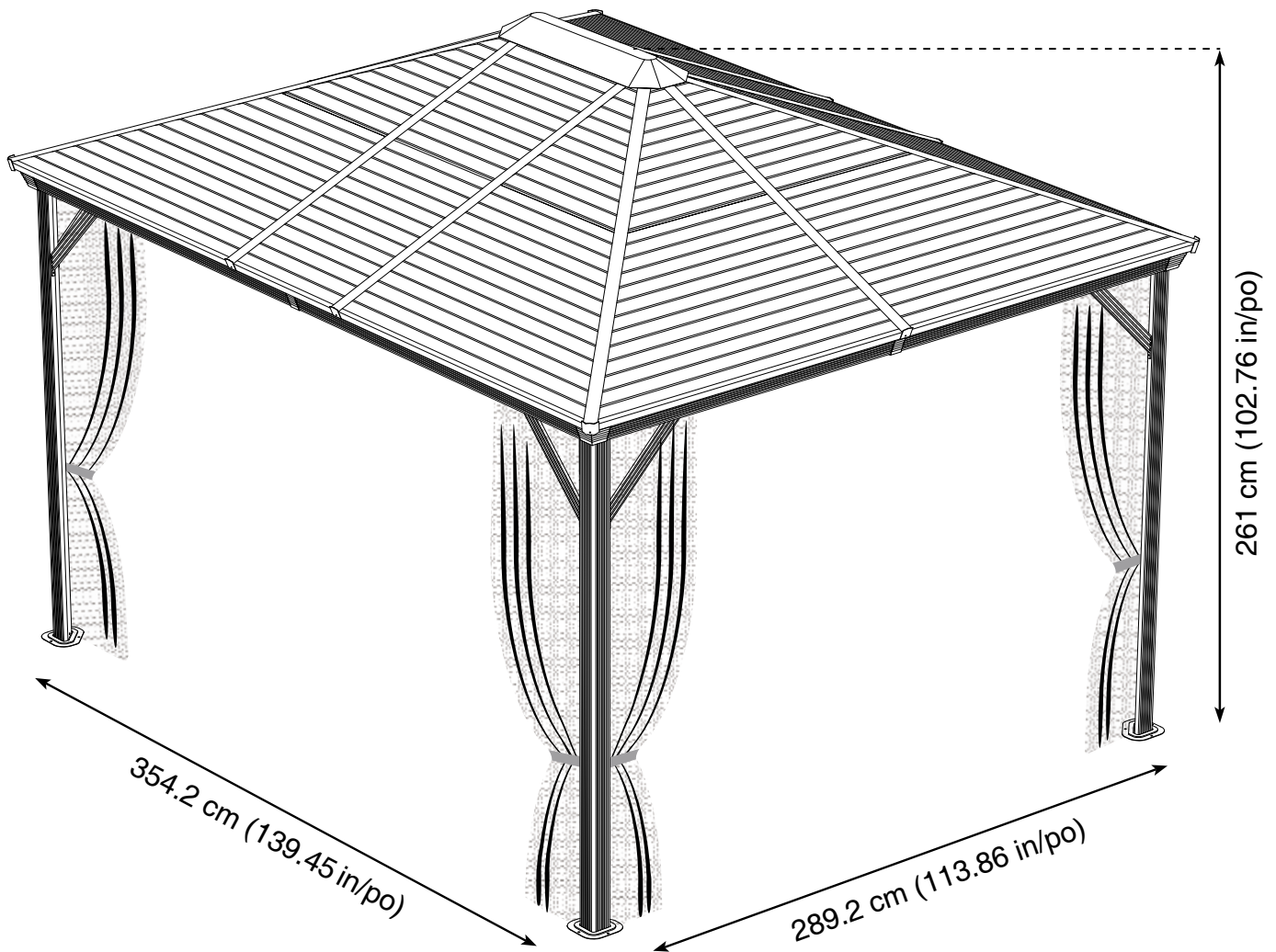

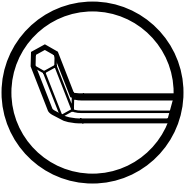

Use the hex keys in the box. / Utilisez les clés hexagonales fournies dans la boîte. /
Utilice las llaves hexagonales en la caja. / 상자에 육각 키를 사용 하십시오. / Verwenden Sie
die Sechskantschlüssel in der Box.

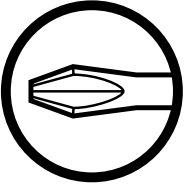

Please use a Phillips screwdriver period / Utilisez un tournevis de type Phillips / Por favor,
use un destornillador Phillips / 십자 드라이버를 사용 하십시오. / Bitte verwenden Sie einen
Kreuzschraubenzieher.



you may need to use a drill for this step. / Vous pouvez avoir besoin d'utiliser une
perceuse pour cette étape. / puede que tenga que utilizar un taladro para este paso. /
이 단계에선 드릴을 사용해야 할 수도 있습니다. / Für diesen Schritt können Sie einen
Bohrer verwenden.



Wearing protective gloves is recommended. / Le port de gants de protection est recommandé /
El uso de guantes de protección se recomienda / 보호 장갑을 착용 하는 것이 좋습니다. /
Das Tragen von Schutzhandschuhen wird empfohlen.



Two or more people are required at this stage. / Deux personnes ou plus sont nécessaires à cette
étape. / Dos o más personas se requieren en esta etapa. / 이 단계에서는 두 명 이상이 필요합니다. /
Für diesen Bauschritt sind 2 oder mehr Personen erforderlich.



Do not screw firmly for now. / Ne pas visser fermement pour l'instant. / No atornille con
firmeza por ahora. / 아직 나사를 단단히 조이지 마십시오. / Bitte die Schrauben zum
jetzigen Zeitpunkt noch nicht fest anziehen.



Sold separately / Vendus séparément / vendido en las opciones /
옵션 판매 / Optional erhältlich

T X 8 (+2)

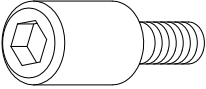

U X 16 (+2)

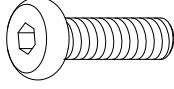

U1 X 40 (+8)

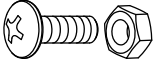

U2 X 2 (+1)

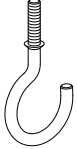

U3 X 1 (+1)

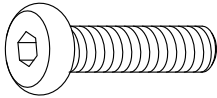

V X 84 (+10)

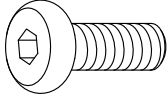

V1 X 16 (+2)

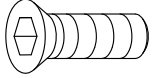

V2 X 20 (+2)

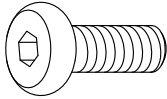

W X 34 (+4)

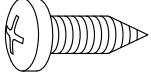

W1 X 16 (+2)

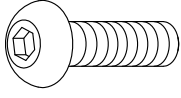



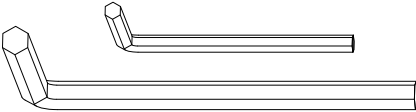



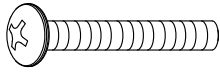

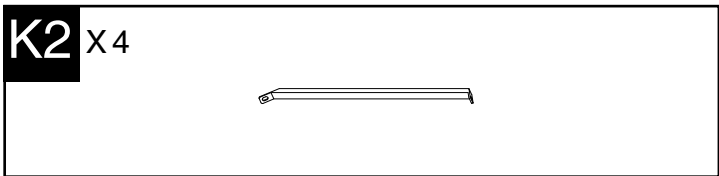
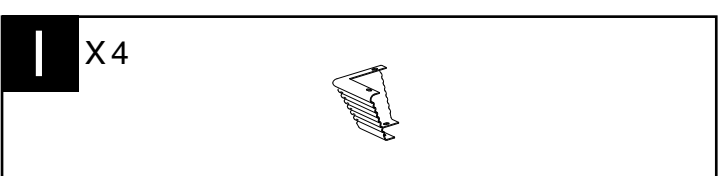
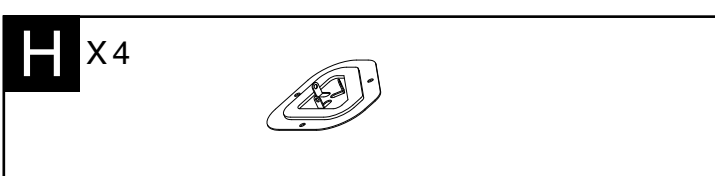
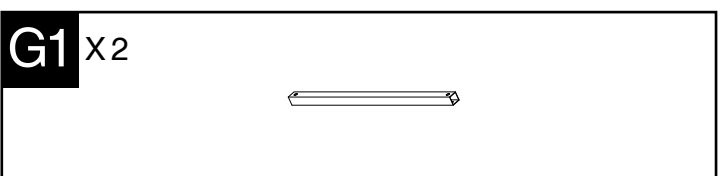
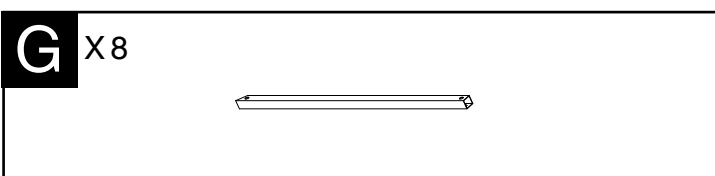
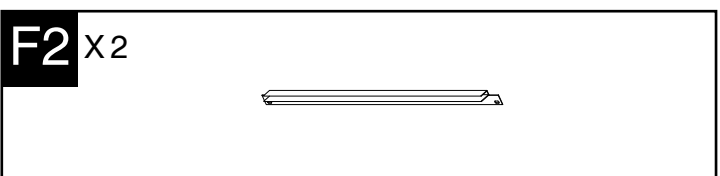
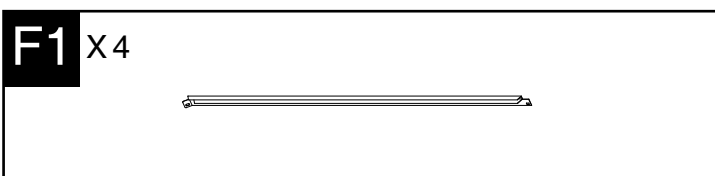
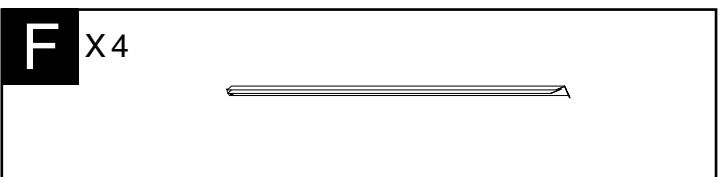
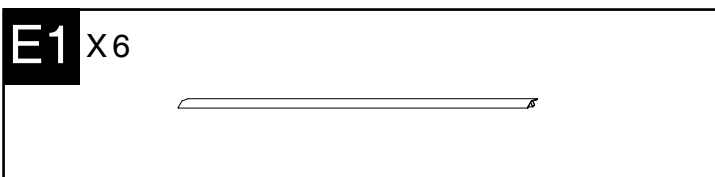
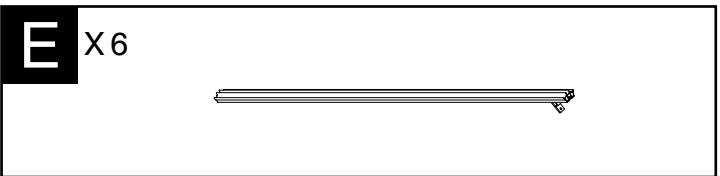
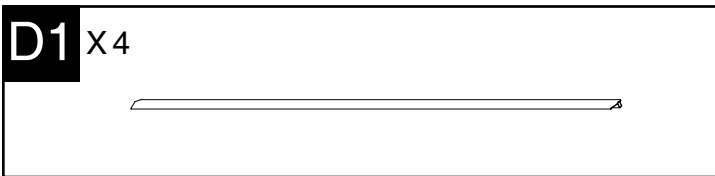
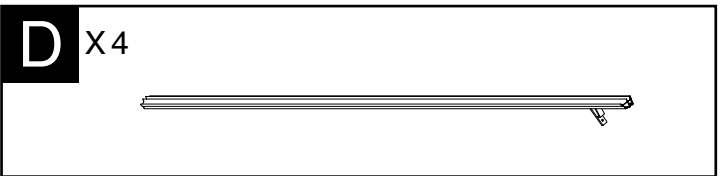
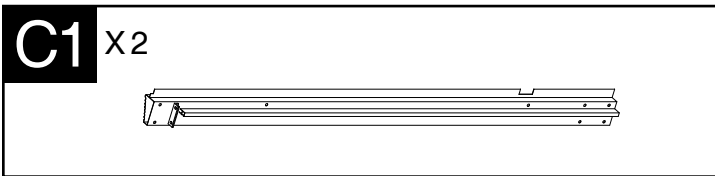
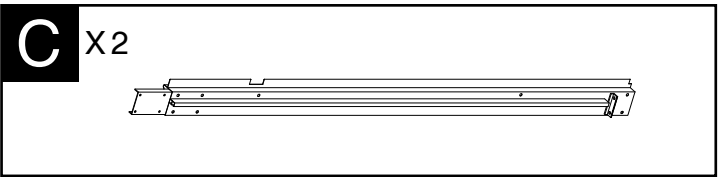
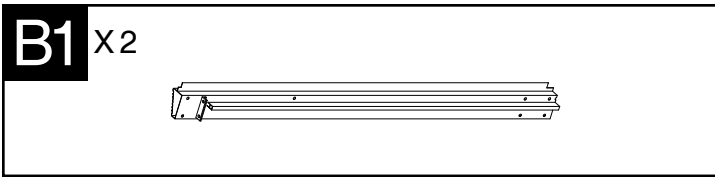
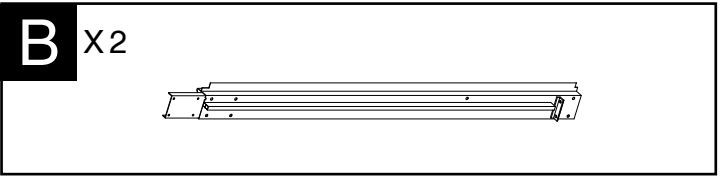

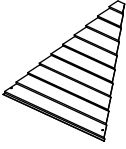
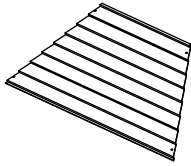
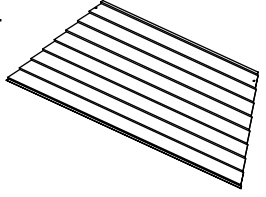
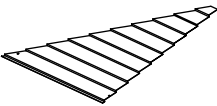
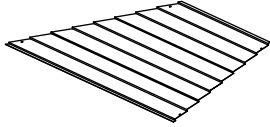
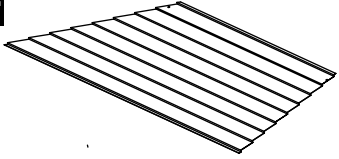
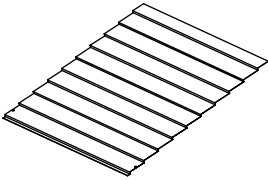
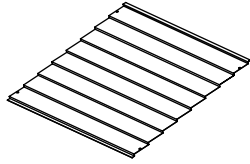
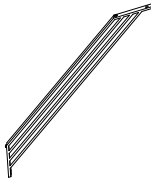

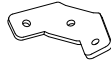
Y X 1

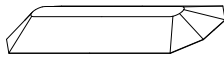
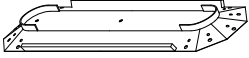

Y1 X 44 (+4)

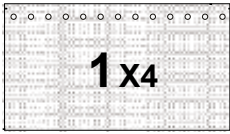

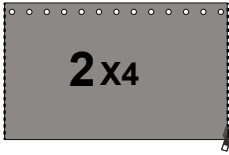

N X4 	N1 X4 	N2 X4 
O X4 	O1 X4 	O2 X4 
P X2 	P1 X4 	
K X8 	L X4 	
M3 X6 	M4 X4 	
Q X4 	R X6 	S X1 
S1 X1 	X X52 optional   	
Net  1 X4 	Curtain  2 X4 	

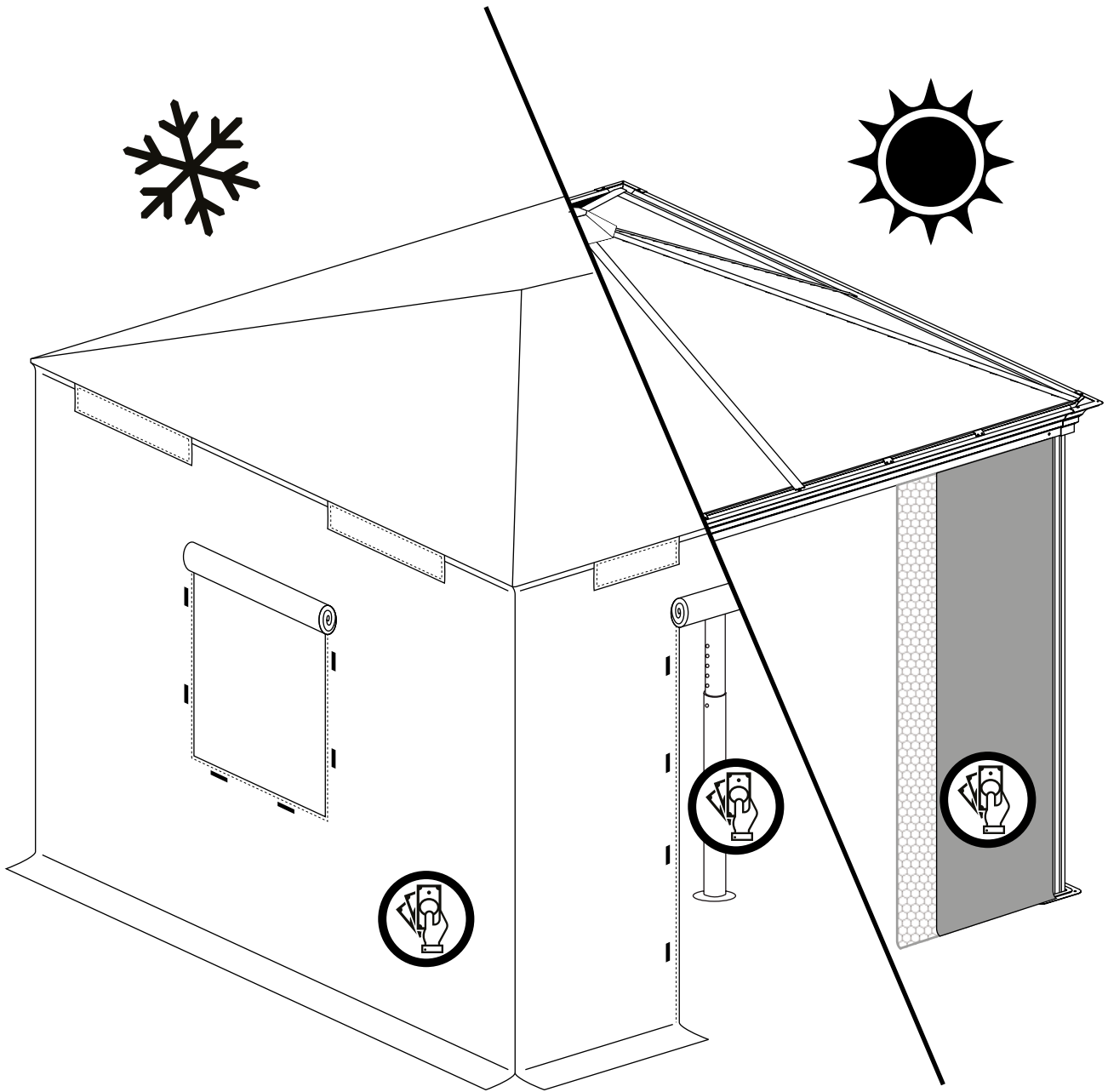
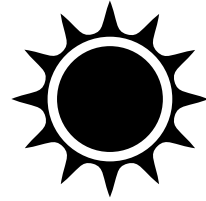
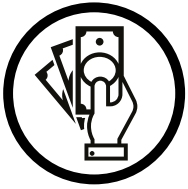

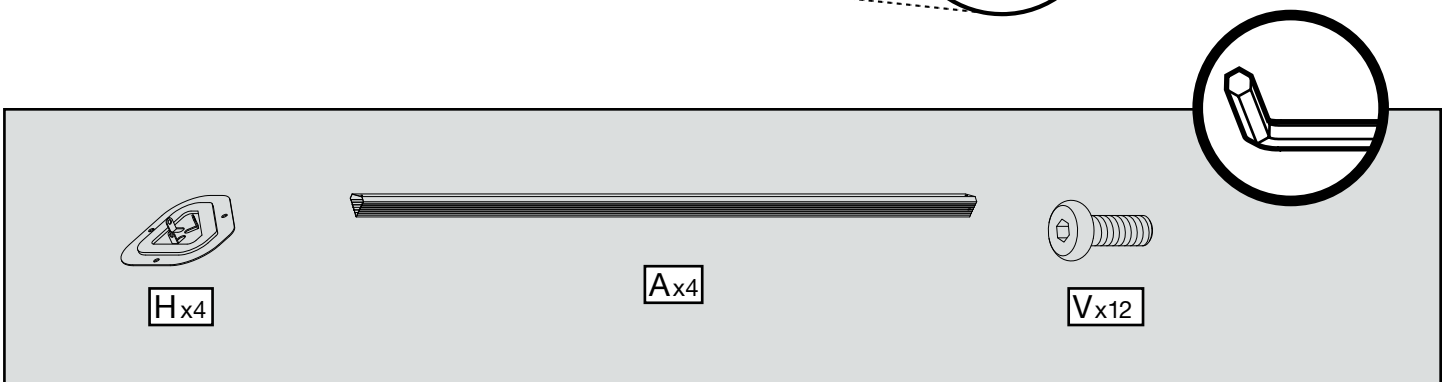
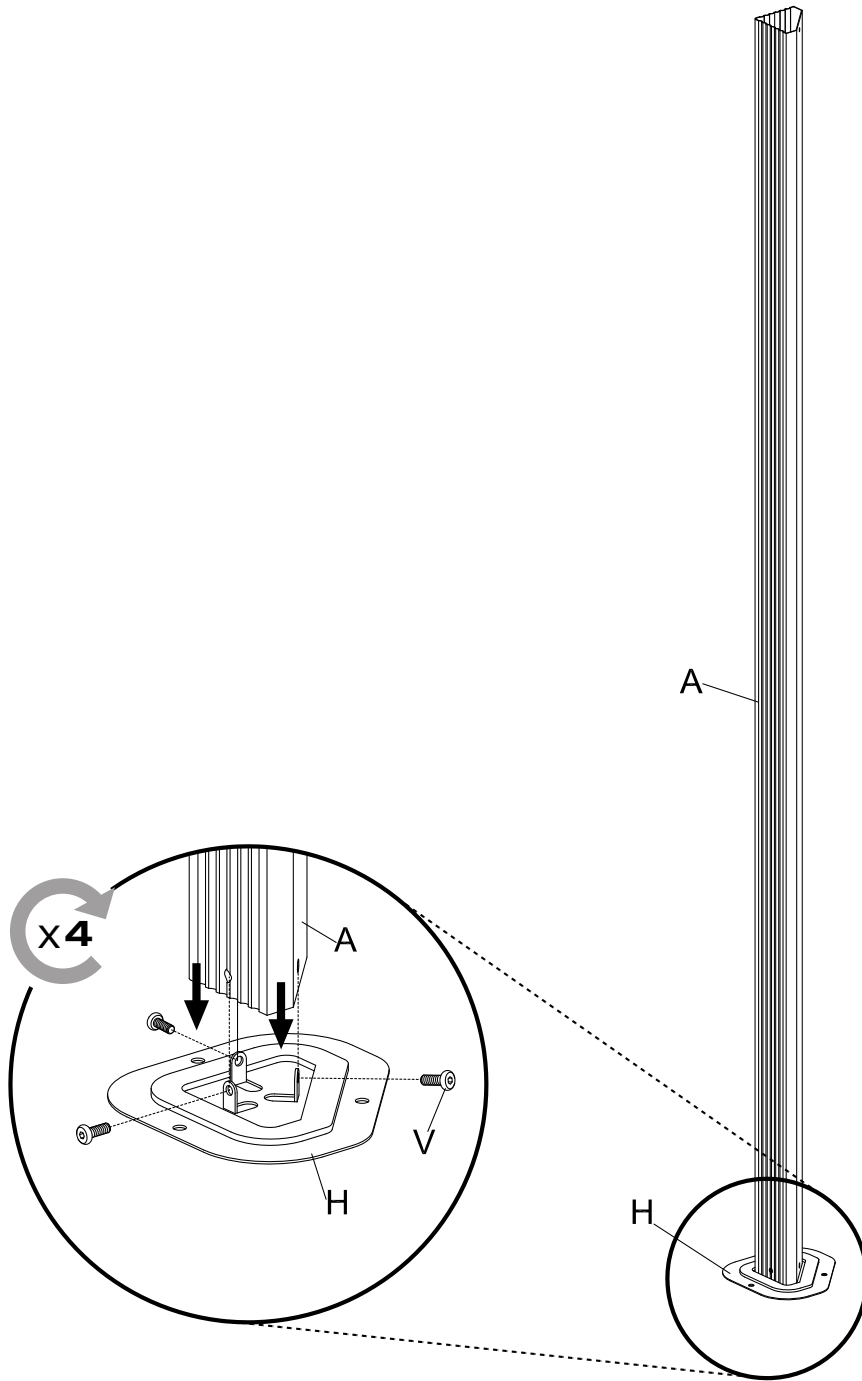

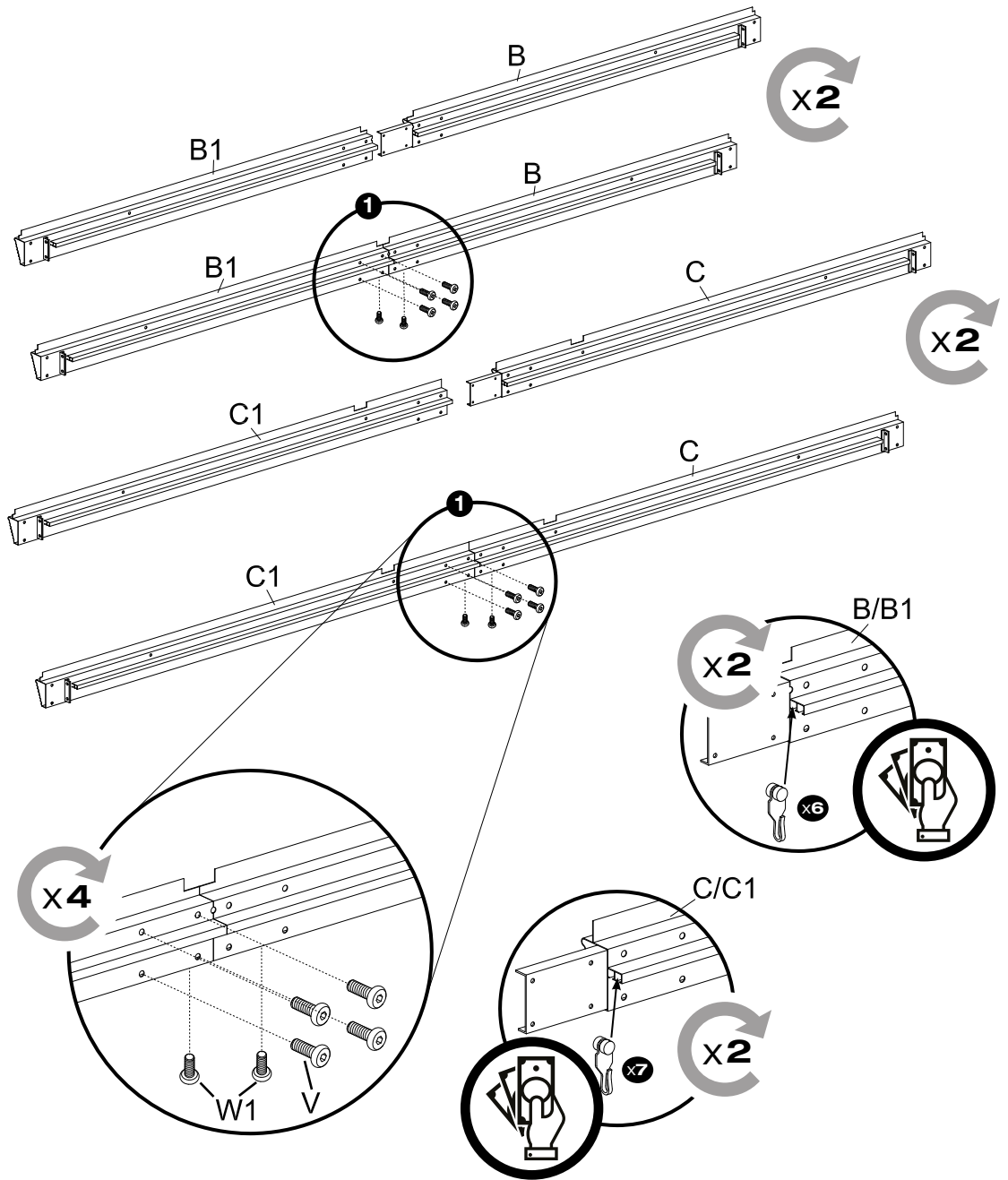

 Bx2	 Cx2		
 B1x2	 C1x2		
 Vx16		 W1x8	 Xx52
			 Xx52

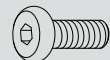
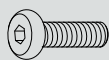
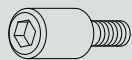
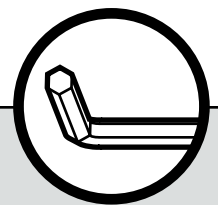
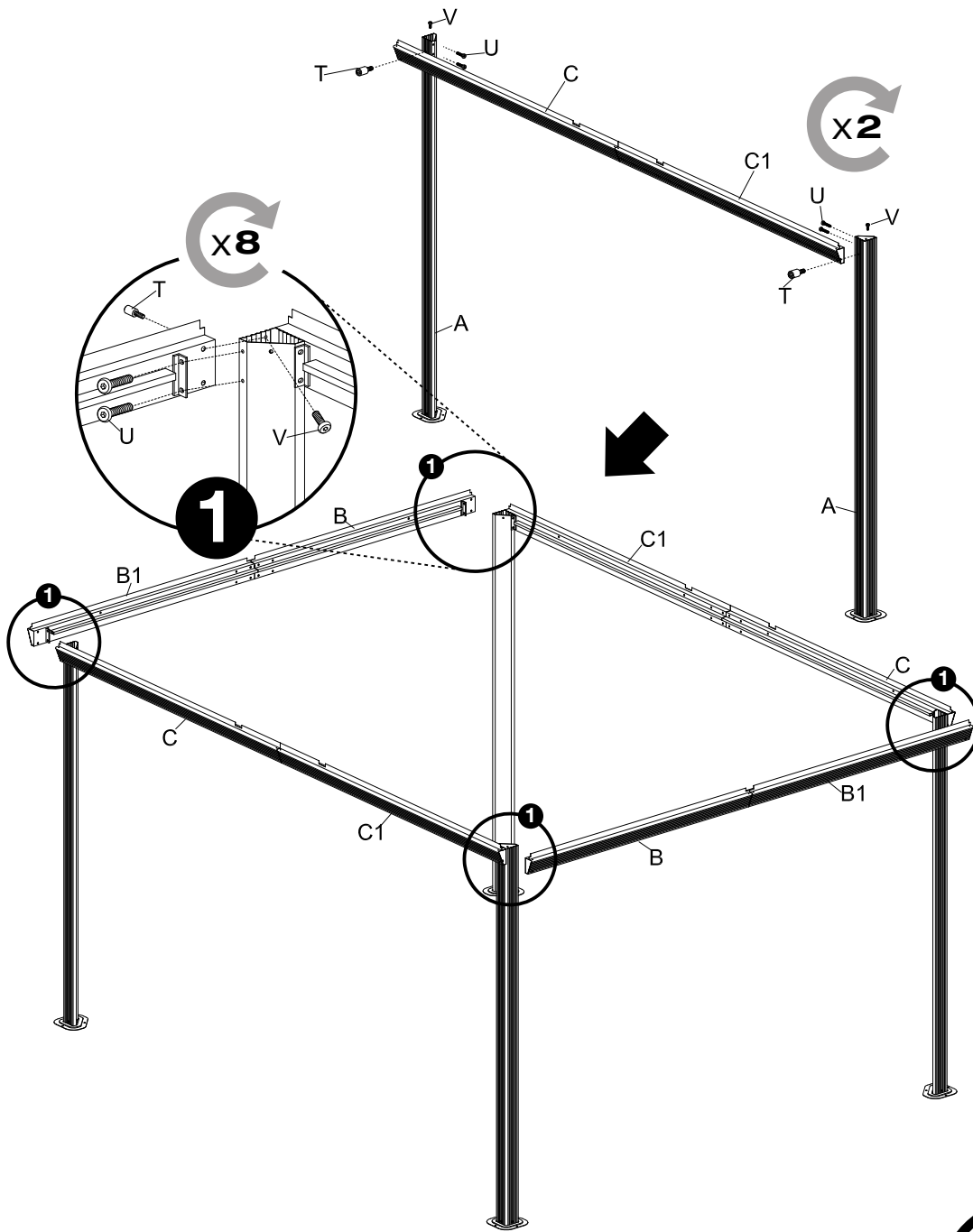

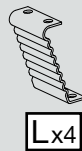
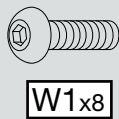
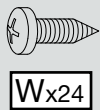
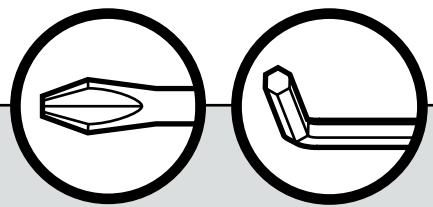
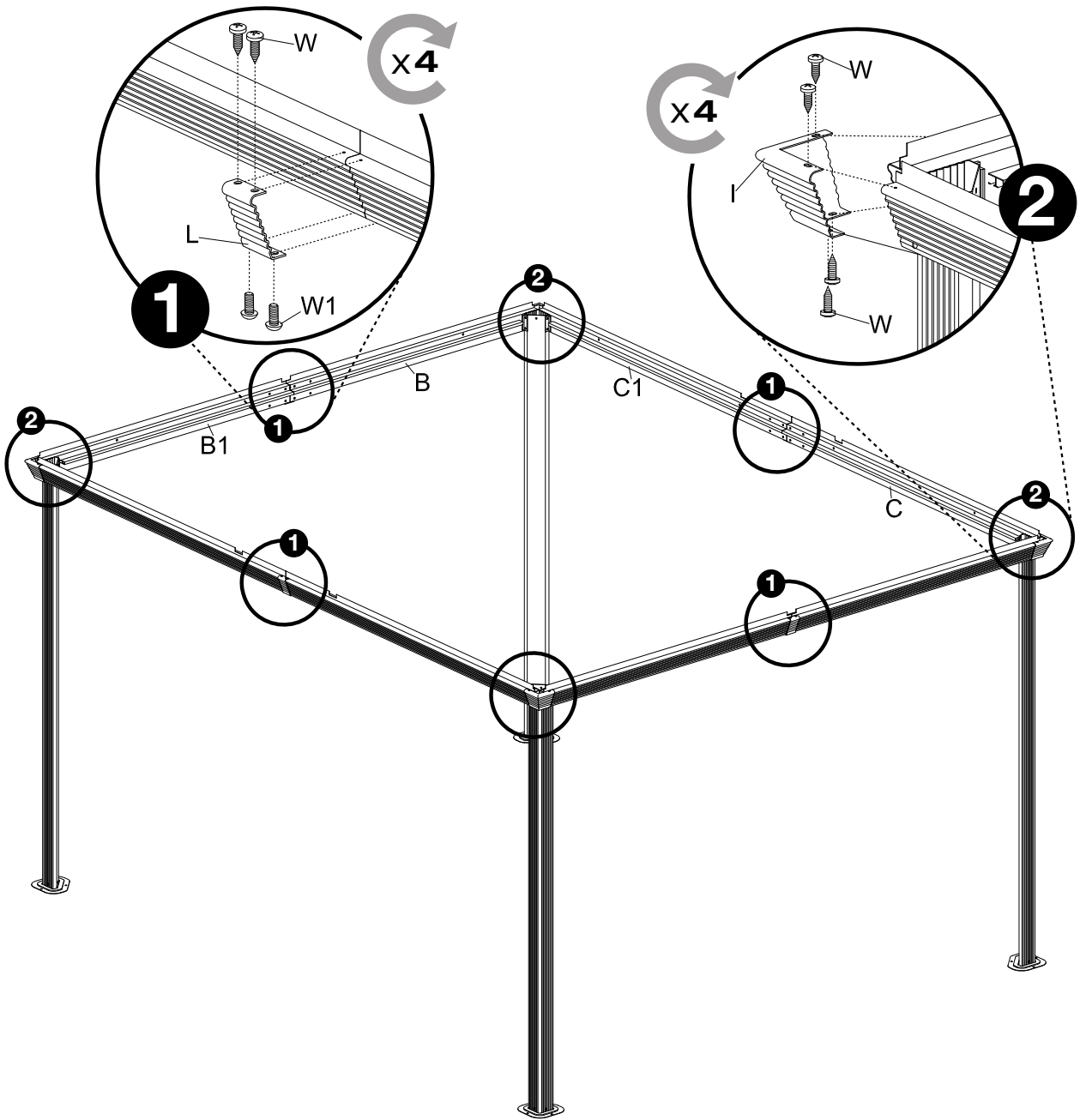

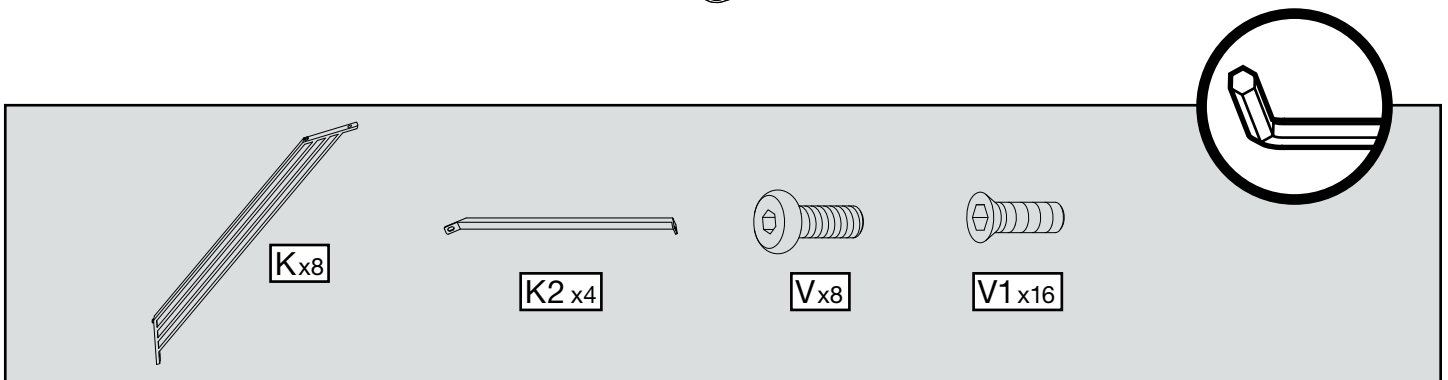
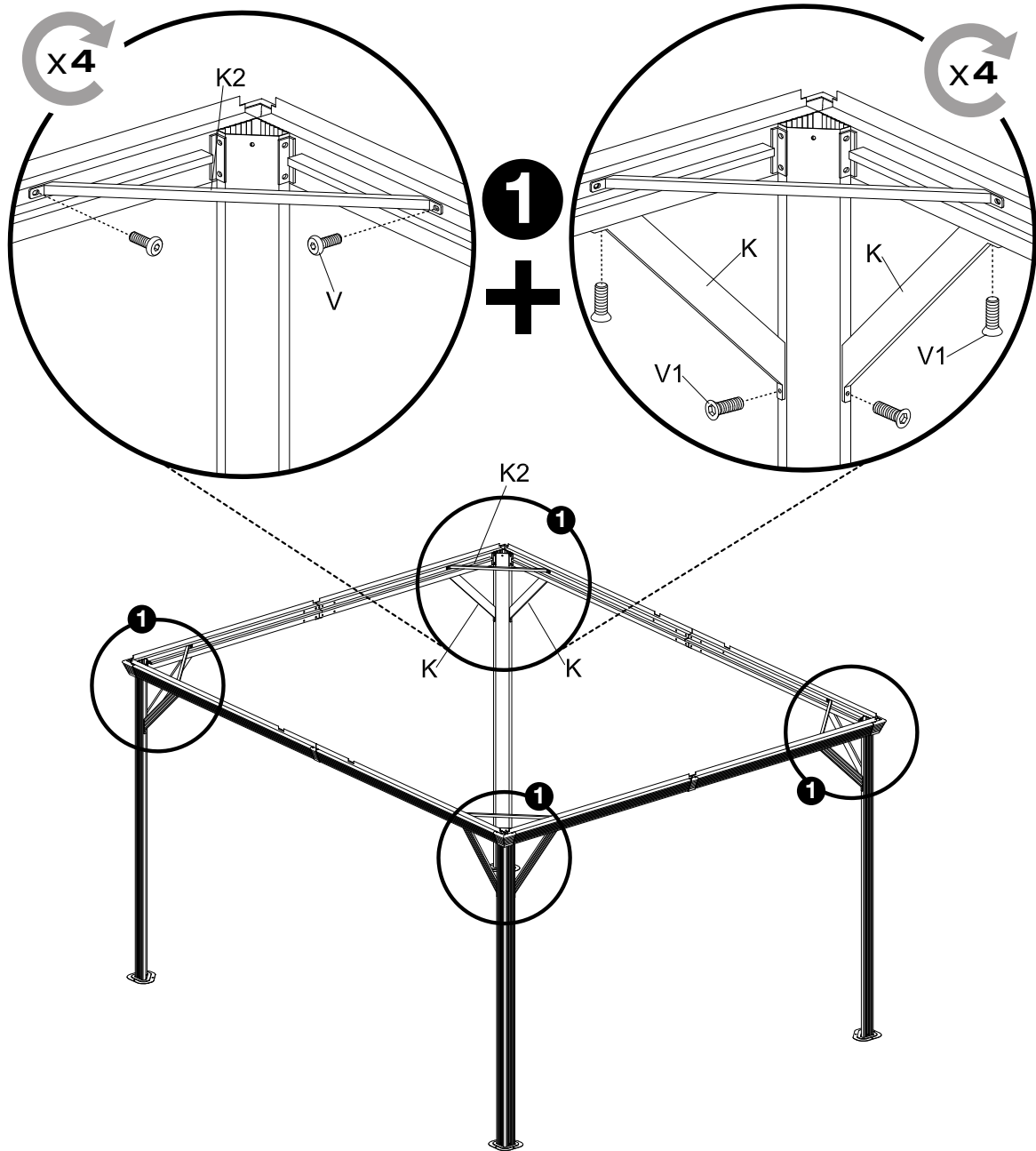

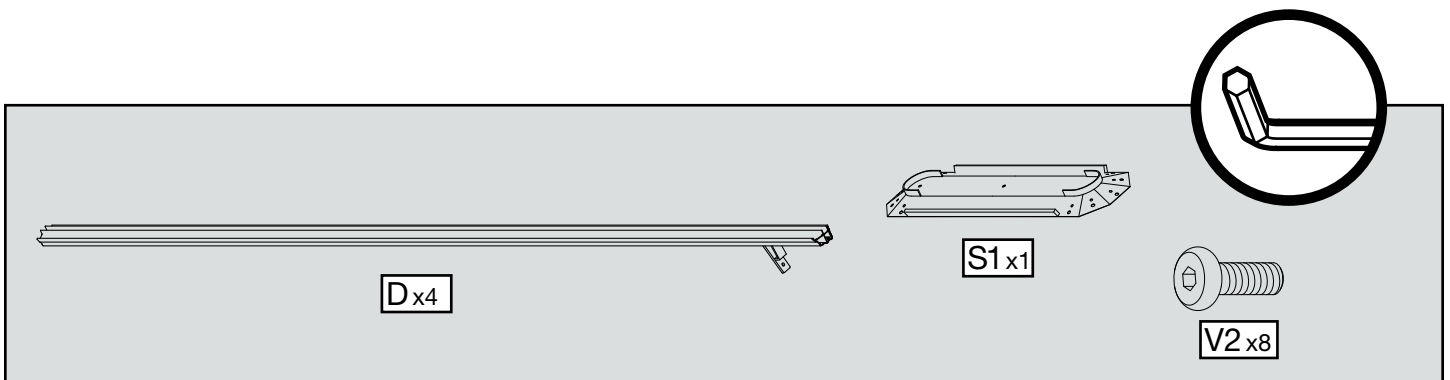
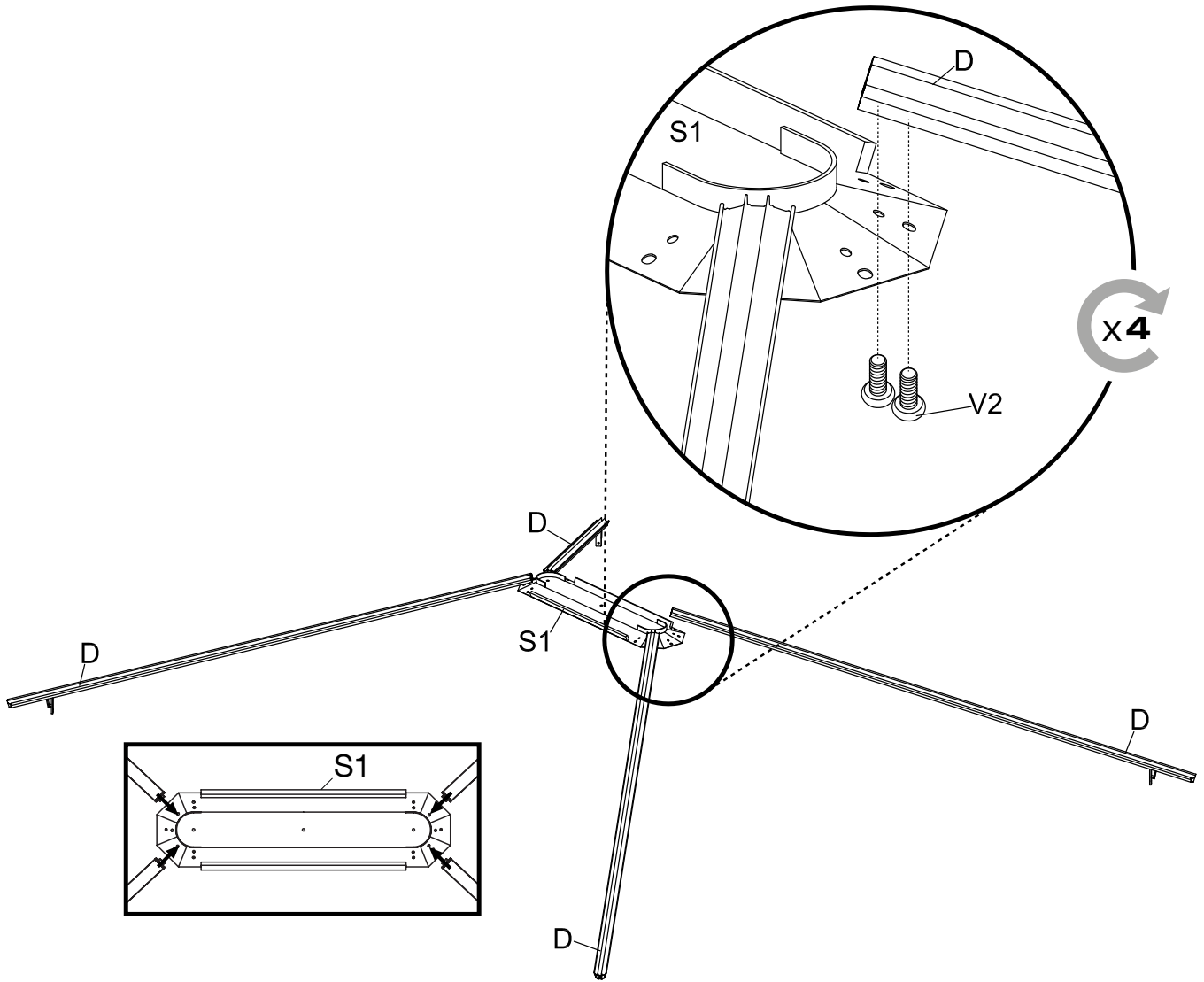

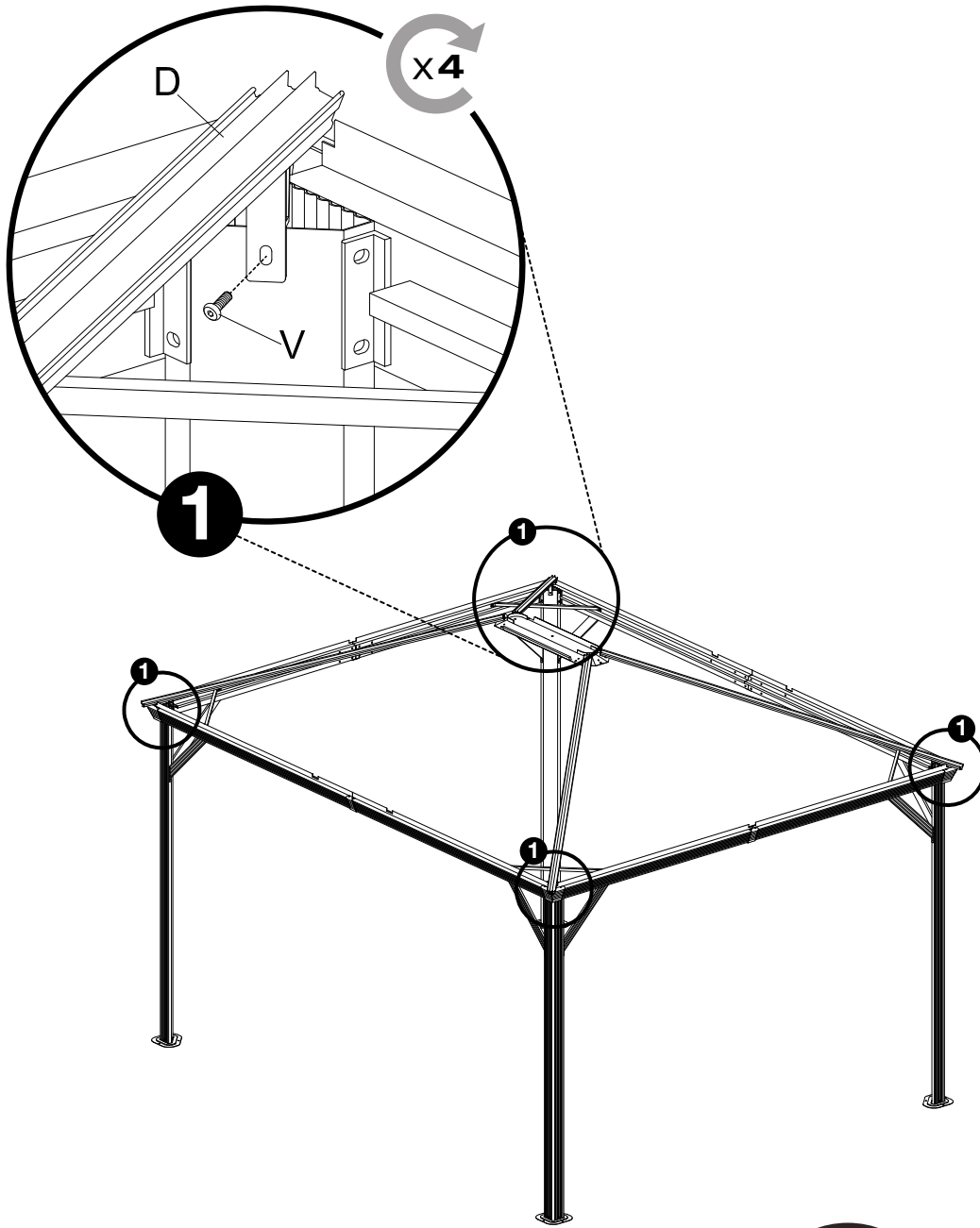

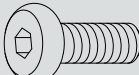

Material list and safety icons:

-  **Vx4**
-  **2+**
- 

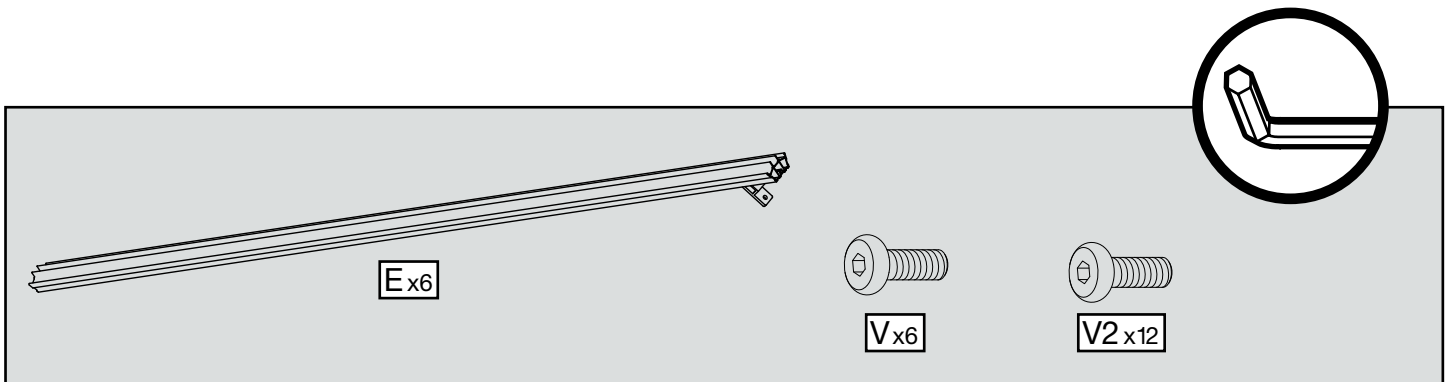
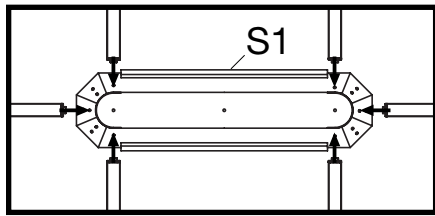
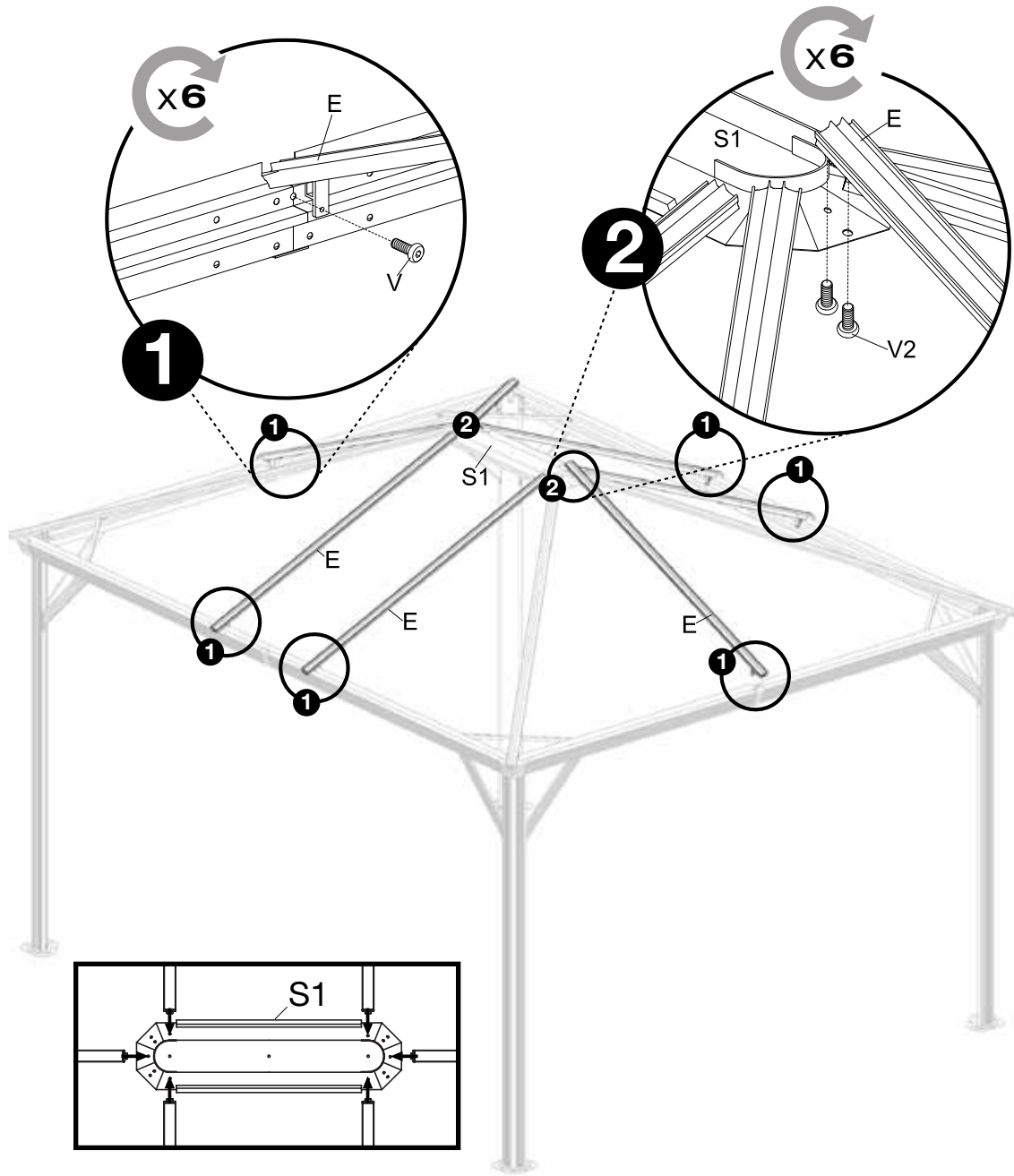

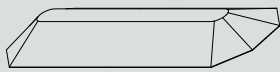
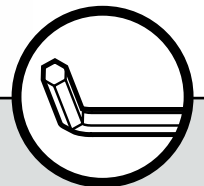
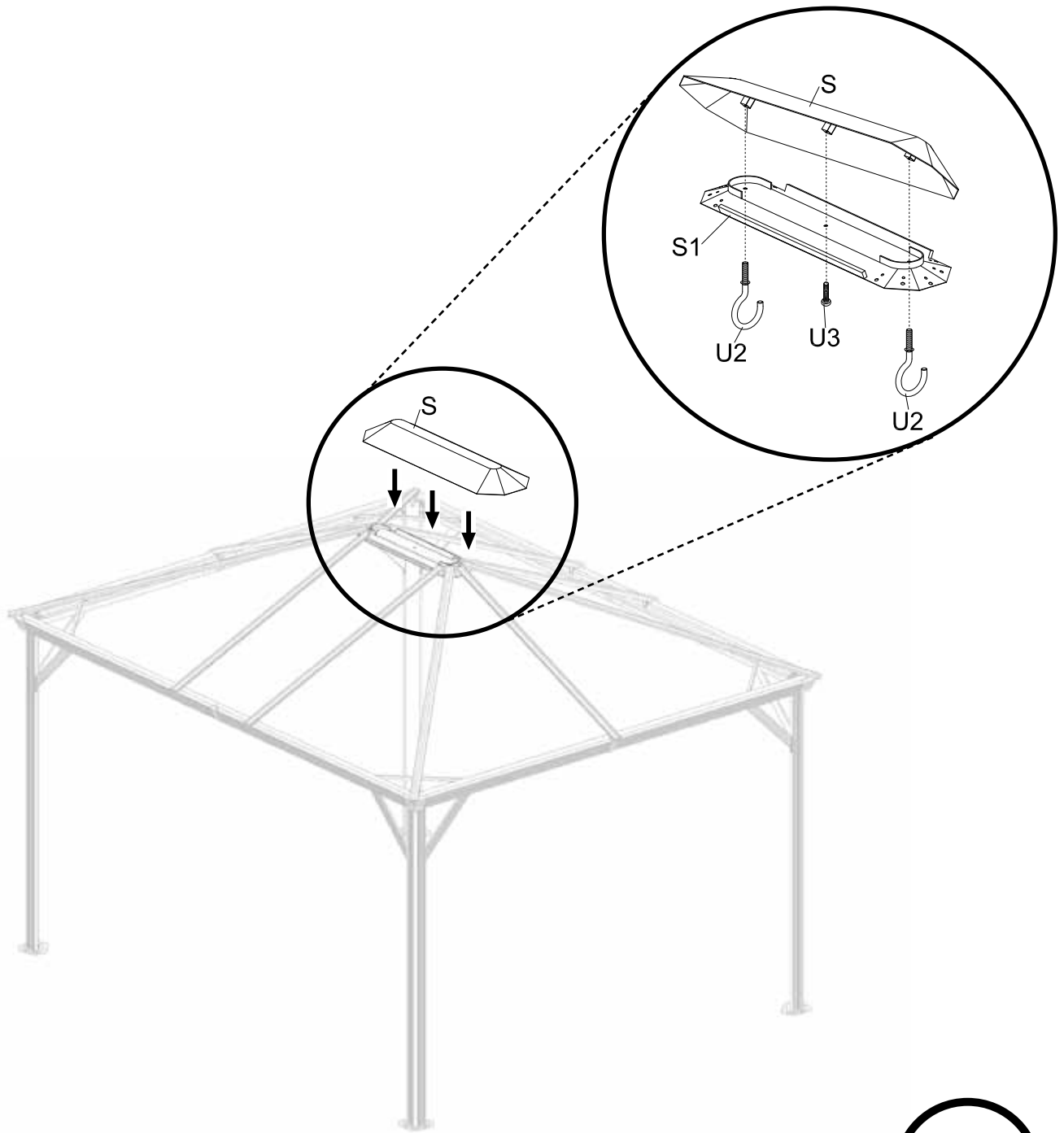

Sx1



U2x2

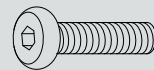

U3x1

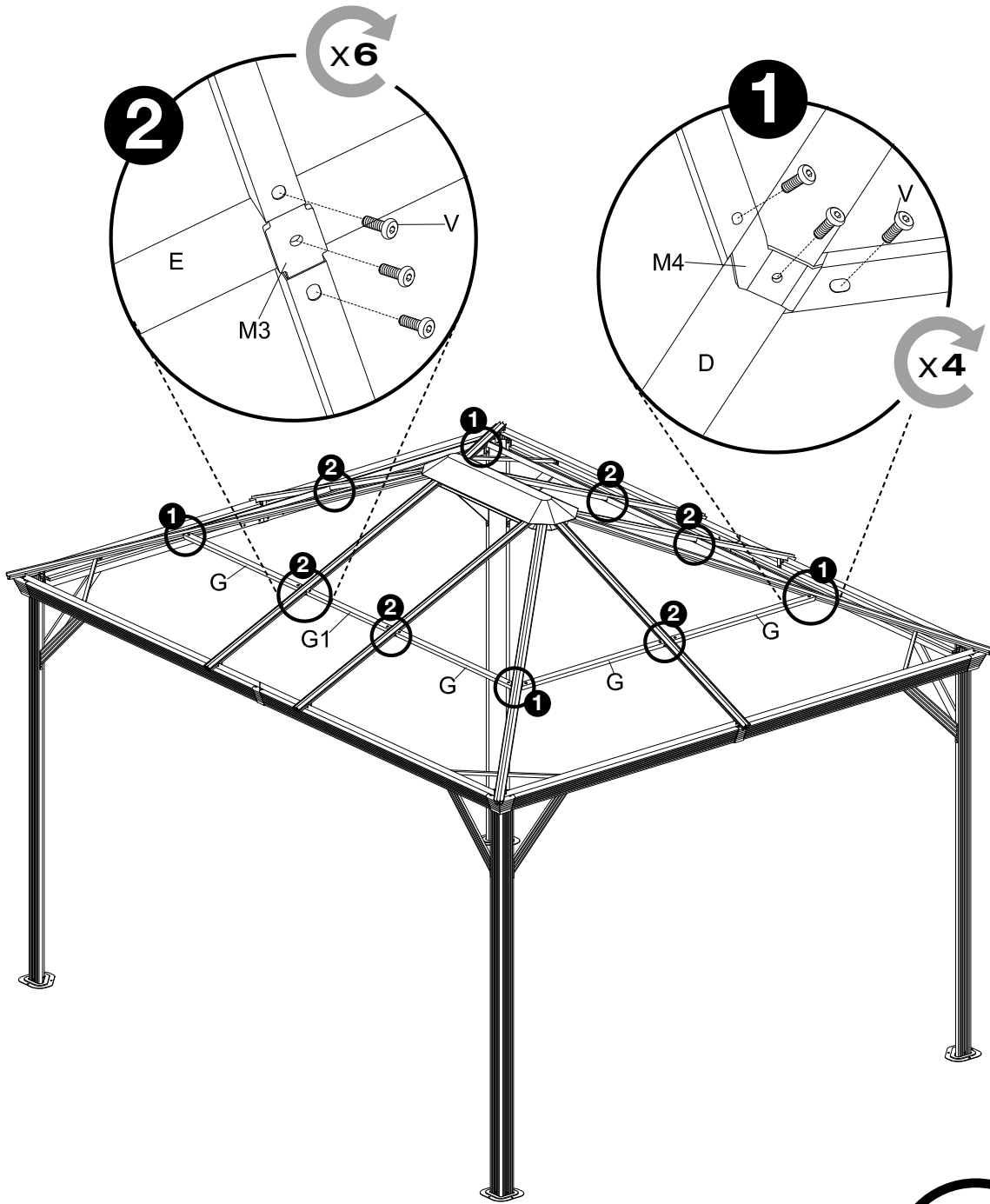

The parts list includes the following items:

- Gx8
- G1x2
- M3x6
- M4x4
- Vx30
- Corner bracket

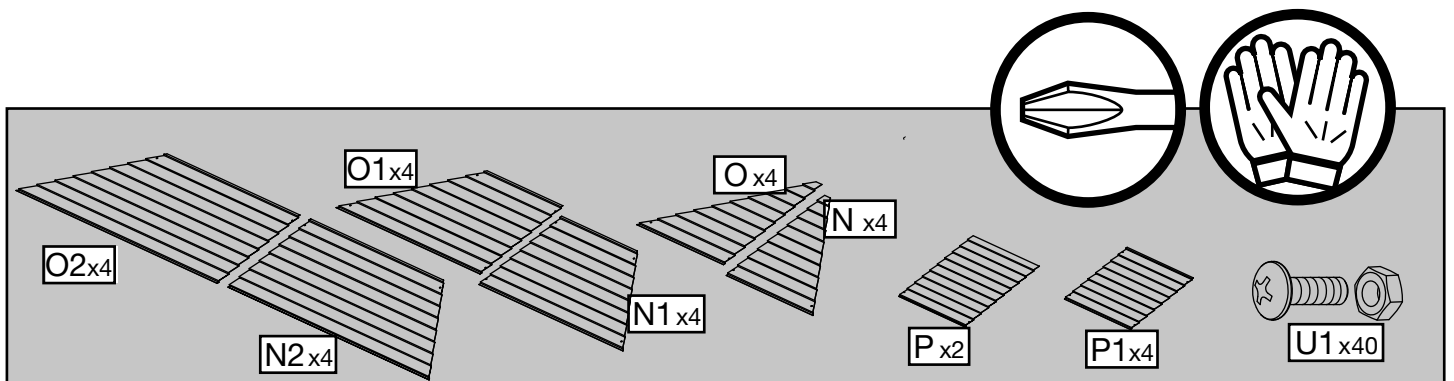
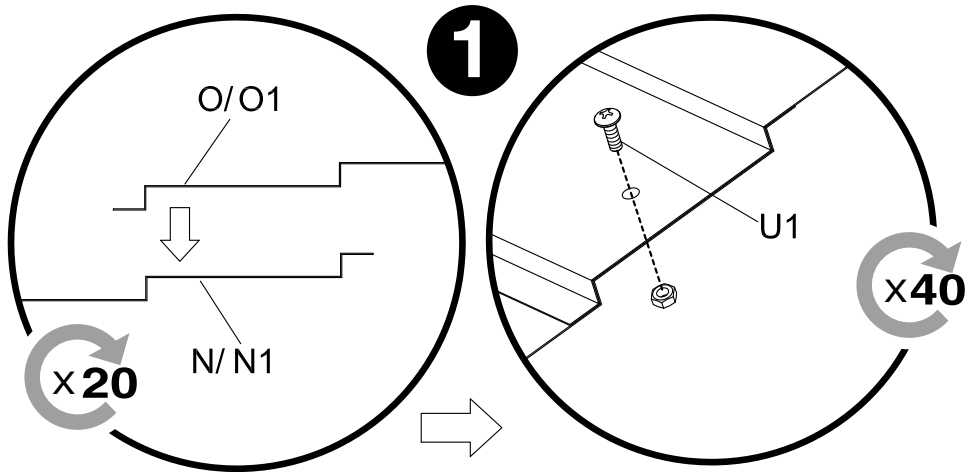
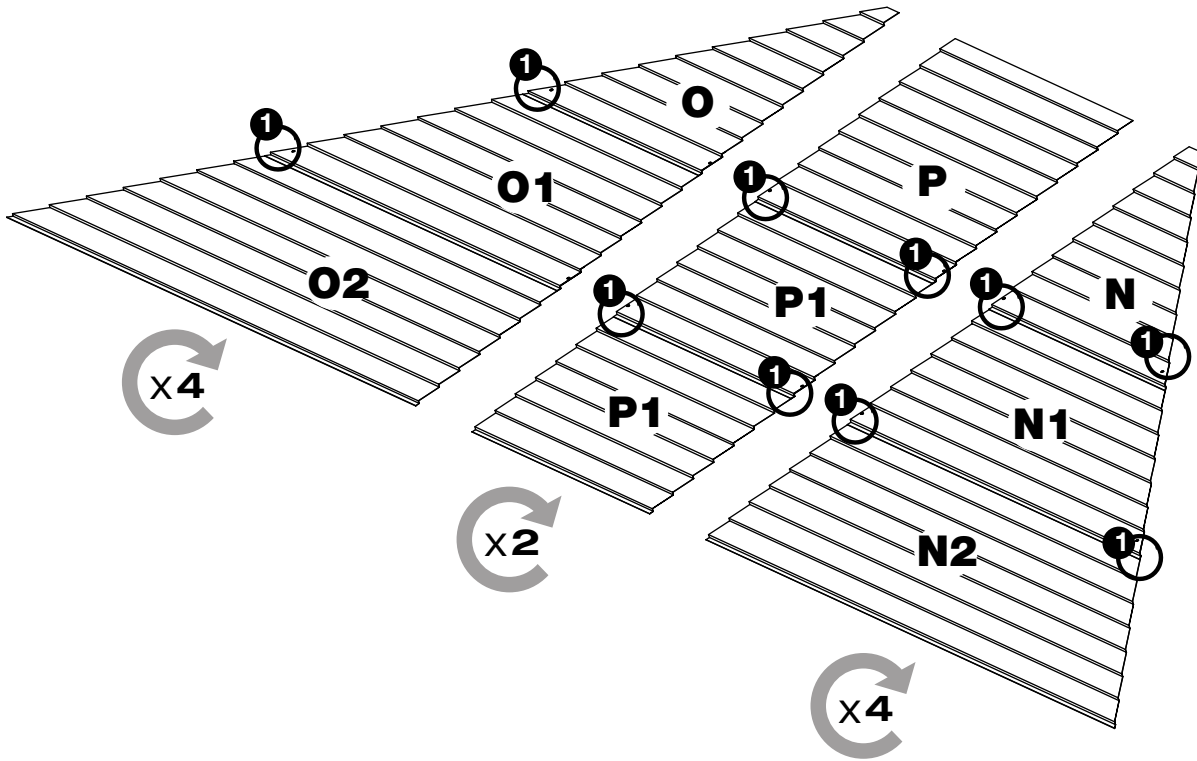

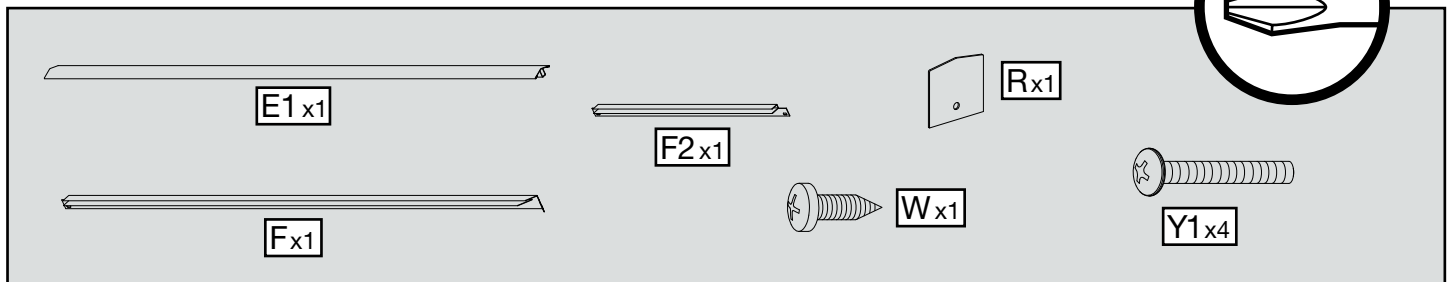
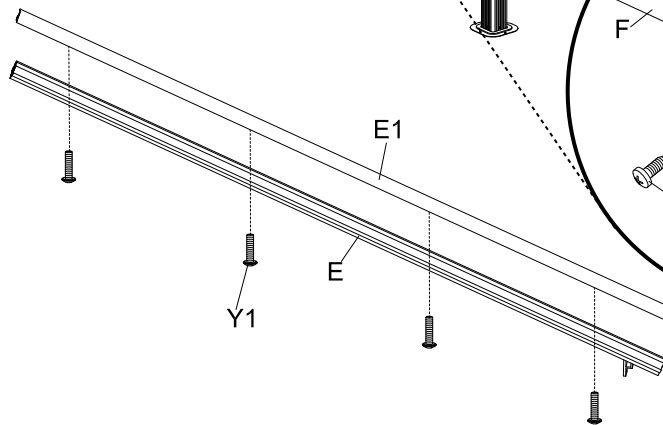
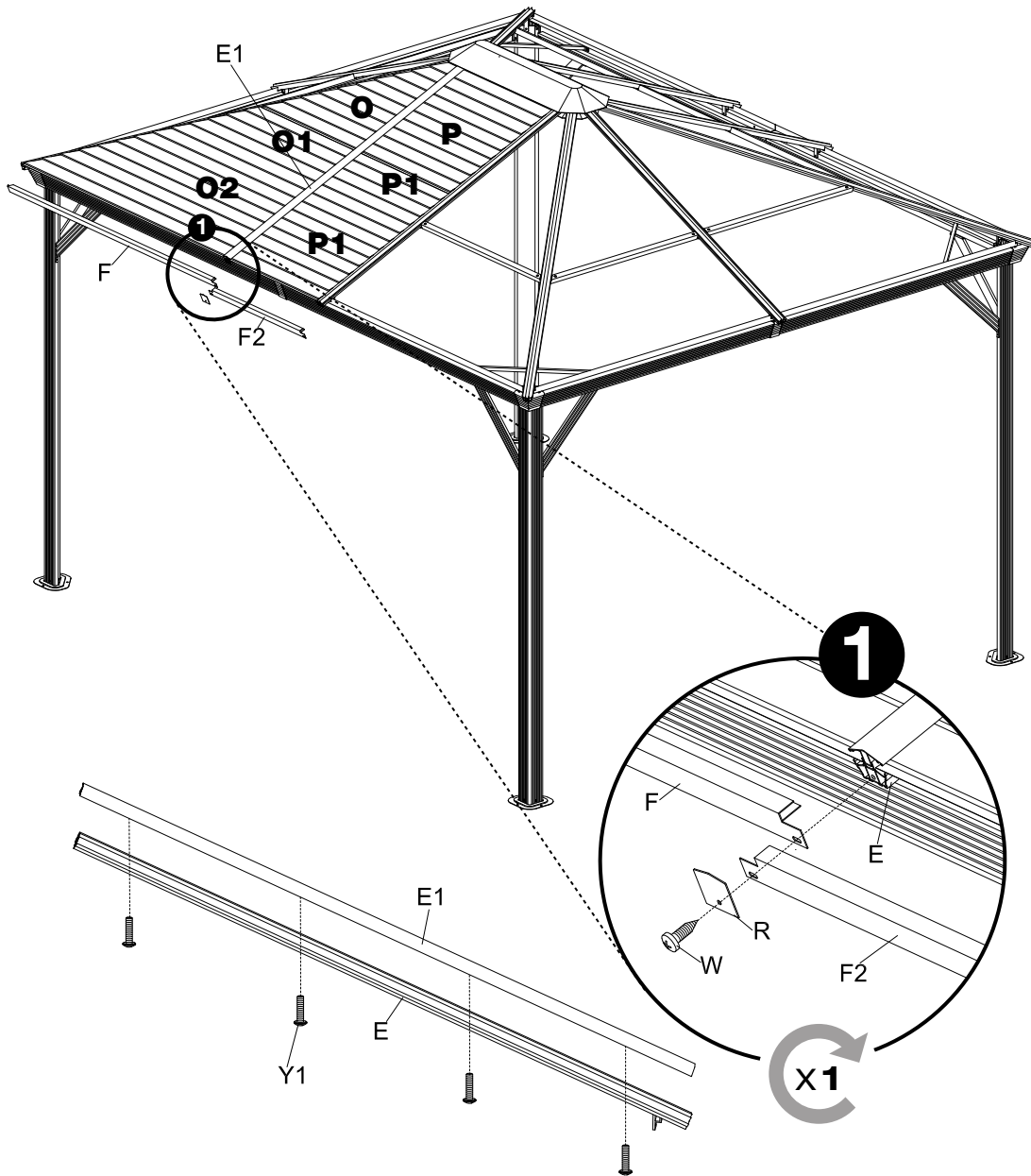

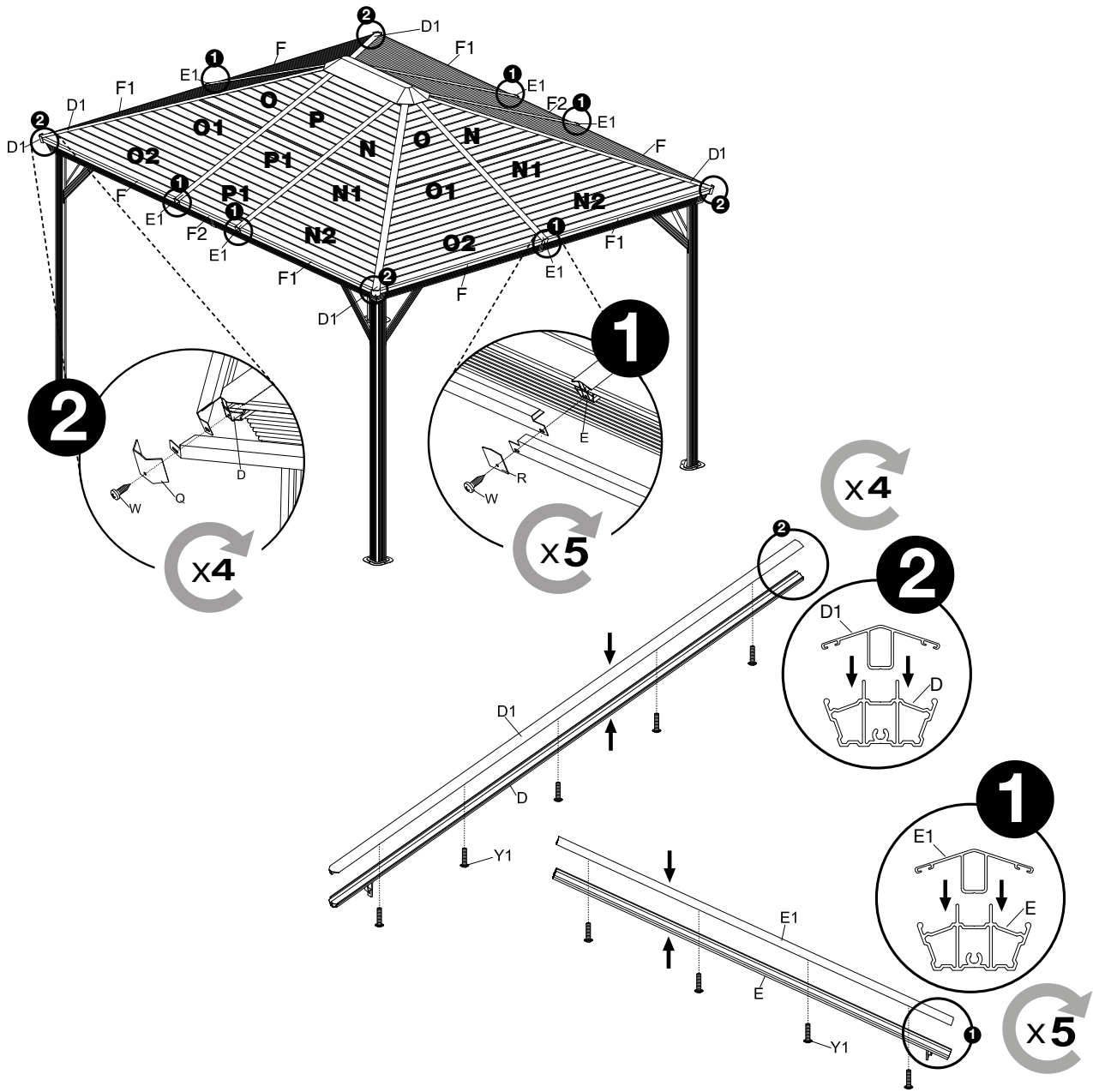

The parts list diagram shows the following components and their quantities:

- D1 x4
- E1 x5
- F x3
- Q x4
- F1 x4
- F2 x1
- R x5
- W x9
- Y1 x40

A circular icon of a screwdriver tip is shown in the bottom right corner of the parts list area.

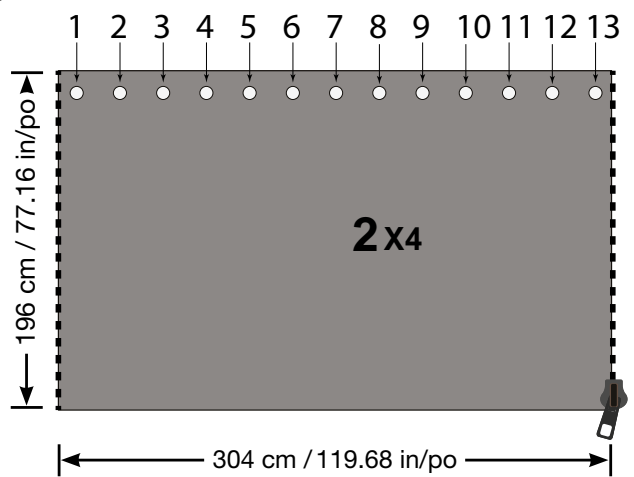
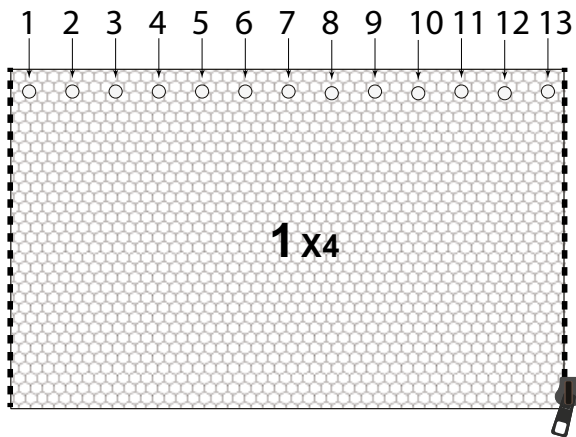
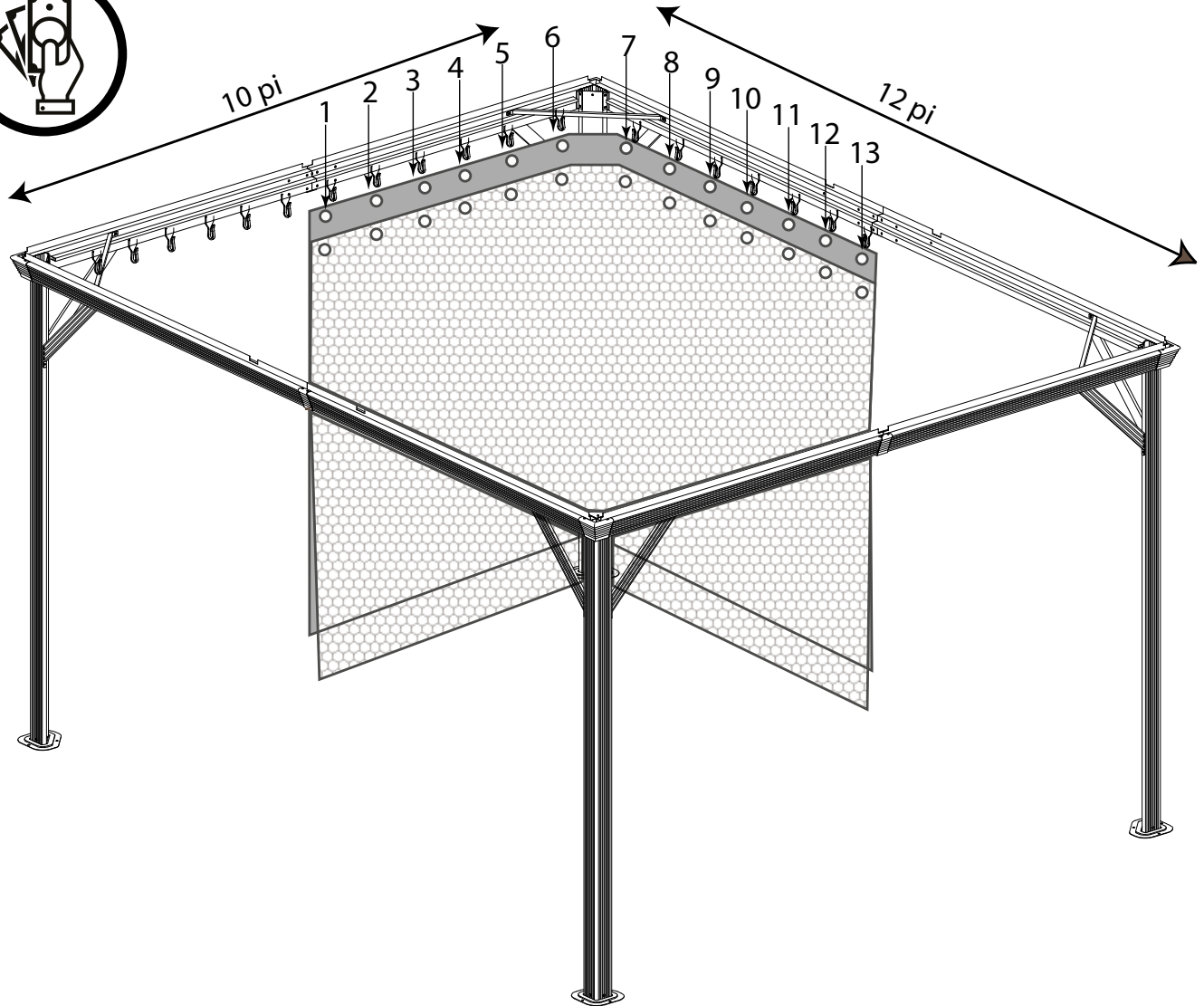
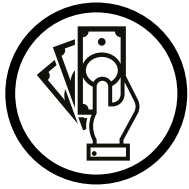

SOJAG ■ I
produits saisonniers • seasonal products